



## Ultra-Wideband, > 40dB Gain Adjust Range, Linear in V/V VARIABLE GAIN AMPLIFIER

### FEATURES

- 710MHz SMALL-SIGNAL BANDWIDTH ( $G = +2V/V$ )
- 320MHz, 4V<sub>pp</sub> BANDWIDTH ( $G = +10V/V$ )
- 0.1dB GAIN FLATNESS to 135MHz
- 2500V/ $\mu$ s SLEW RATE
- > 40dB GAIN ADJUST RANGE
- HIGH GAIN ACCURACY: 20dB  $\pm$ 0.3dB
- HIGH OUTPUT CURRENT:  $\pm$ 90mA

### APPLICATIONS

- DIFFERENTIAL LINE RECEIVERS
- DIFFERENTIAL EQUALIZERS
- PULSE AMPLITUDE COMPENSATION
- VARIABLE ATTENUATORS
- VOLTAGE-TUNABLE ACTIVE FILTERS

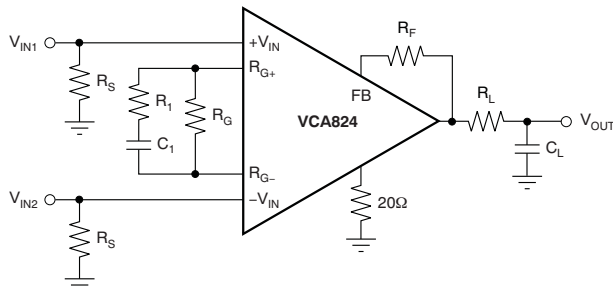

**Differential Equalizer**

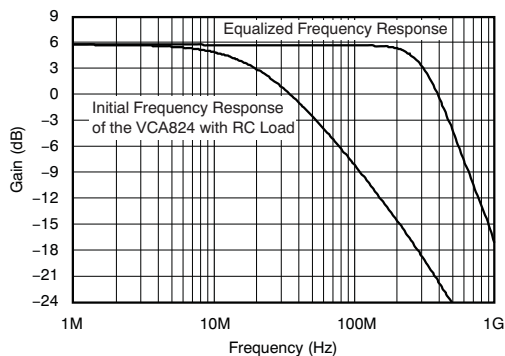

**Differential Equalization of an RC Load**

### DESCRIPTION

The VCA824 is a dc-coupled, wideband, linear in V/V, continuously variable, voltage-controlled gain amplifier. It provides a differential input to single-ended conversion with a high-impedance gain control input used to vary the gain down 40dB from the nominal maximum gain set by the gain resistor ( $R_G$ ) and feedback resistor ( $R_F$ ).

The VCA824 internal architecture consists of two input buffers and an output current feedback amplifier stage integrated with a multiplier core to provide a complete variable gain amplifier (VGA) system that does not require external buffering. The maximum gain is set externally with two resistors, providing flexibility in designs. The maximum gain is intended to be set between +2V/V and +40V/V. Operating from  $\pm$ 5V supplies, the gain control voltage for the VCA824 adjusts the gain linearly in V/V as the control voltage varies from +1V to -1V. For example, set for a maximum gain of +10V/V, the VCA824 provides 10V/V, at +1V input, to 0.1V/V at -1V input of gain control range. The VCA824 offers excellent gain linearity. For a 20dB maximum gain, and a gain-control input voltage varying between 0V and 1V, the gain does not deviate by more than  $\pm$ 0.3dB (maximum at +25°C).

### VCA824 RELATED PRODUCTS

SINGLES	DUALS	GAIN ADJUST RANGE (dB)	INPUT NOISE (nV/ $\sqrt$ Hz)	SIGNAL BANDWIDTH (MHz)
VCA810	—	80	2.4	35
—	VCA2612	45	1.25	80
—	VCA2613	45	1	80
—	VCA2615	52	0.8	50
—	VCA2617	48	4.1	50
VCA820	—	40	8.2	150
VCA821	—	40	6.0	420
VCA822	—	40	8.2	150
VCA824	—	40	6.0	420



Please be aware that an important notice concerning availability, standard warranty, and use in critical applications of Texas Instruments semiconductor products and disclaimers thereto appears at the end of this data sheet.

X2Y is a registered trademark of X2Y Attenuators LLC.  
All other trademarks are the property of their respective owners.



This integrated circuit can be damaged by ESD. Texas Instruments recommends that all integrated circuits be handled with appropriate precautions. Failure to observe proper handling and installation procedures can cause damage.

ESD damage can range from subtle performance degradation to complete device failure. Precision integrated circuits may be more susceptible to damage because very small parametric changes could cause the device not to meet its published specifications.

**ORDERING INFORMATION<sup>(1)</sup>**

PRODUCT	PACKAGE-LEAD	PACKAGE DESIGNATOR	SPECIFIED TEMPERATURE RANGE	PACKAGE MARKING	ORDERING NUMBER	TRANSPORT MEDIA, QUANTITY
VCA824	SO-14	D	-40°C to +85°C	VCA824ID	VCA824ID	Rail, 50
					VCA824IDR	Tape and Reel, 2500
VCA824	MSOP-10	DGS	-40°C to +85°C	BOT	VCA824IDGST	Tape and Reel, 250
					VCA824IDGSR	Tape and Reel, 2500

(1) For the most current package and ordering information see the Package Option Addendum at the end of this document, or see the TI web site at [www.ti.com](http://www.ti.com).

**ABSOLUTE MAXIMUM RATINGS**

Over operating free-air temperature range (unless otherwise noted).

PARAMETER		VCA824	UNIT
Power Supply		±6.5	V
Internal Power Dissipation		See Thermal Characteristics	
Input Voltage Range		±V <sub>S</sub>	V
Storage Temperature Range		-65 to +125	°C
Lead Temperature (soldering, 10s)		+260	°C
Junction Temperature (T <sub>J</sub> )		+150	°C
Junction Temperature (T <sub>J</sub> ), Maximum Continuous Operation		+140	°C
ESD Rating	Human Body Model (HBM)	2000	V
	Charge Device Model (CDM)	1000	V
	Machine Model (MM)	200	V

**PIN CONFIGURATION**

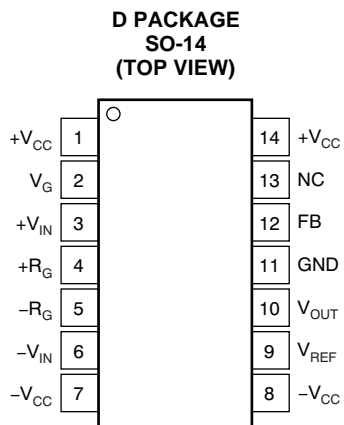

NC = No Connection

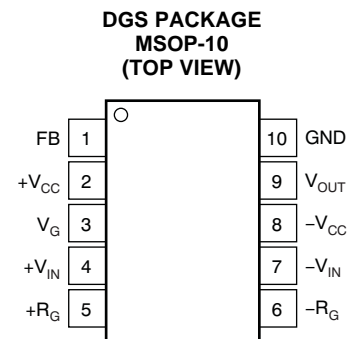

**ELECTRICAL CHARACTERISTICS:  $V_S = \pm 5V$** 

 At  $A_{V_{MAX}} = +10V/V$ ,  $V_G = +1V$ ,  $R_F = 402\Omega$ ,  $R_G = 80\Omega$ , and  $R_L = 100\Omega$ , unless otherwise noted.

PARAMETER	CONDITIONS	VCA824				UNITS	MIN/ MAX	TEST LEVEL <sup>(1)</sup>
		TYP	MIN/MAX OVER TEMPERATURE					
		+25°C	+25°C <sup>(2)</sup>	0°C to 70°C <sup>(3)</sup>	-40°C to +85°C <sup>(3)</sup>			
<b>AC PERFORMANCE</b>								
Small-Signal Bandwidth	$A_{V_{MAX}} = +2V/V$ , $V_G = +1V$ , $V_O = 500mV_{PP}$	710				MHz	typ	C
	$A_{V_{MAX}} = +10V/V$ , $V_G = +1V$ , $V_O = 500mV_{PP}$	420				MHz	typ	C
	$A_{V_{MAX}} = +40V/V$ , $V_G = +1V$ , $V_O = 500mV_{PP}$	170				MHz	typ	C
Large-Signal Bandwidth	$A_{V_{MAX}} = +10V/V$ , $V_G = +1V$ , $V_O = 4V_{PP}$	320				MHz	typ	C
Gain Control Bandwidth	$V_O = 200mV_{PP}$	330	240	235	235	MHz	min	B
Bandwidth for 0.1dB Flatness	$A_{V_{MAX}} = +10V/V$ , $V_G = +1V$ , $V_O = 2V_{PP}$	135				MHz	typ	C
Slew Rate	$A_{V_{MAX}} = +10V/V$ , $V_G = +1V$ , $V_O = 4V$ Step	2500	1800	1700	1700	V/ $\mu$ s	min	B
Rise-and-Fall Time	$A_{V_{MAX}} = +10V/V$ , $V_G = +1V$ , $V_O = 4V$ Step	1.5	1.8	1.9	1.9	ns	max	B
Settling Time to 0.01%	$A_{V_{MAX}} = +10V/V$ , $V_G = +1V$ , $V_O = 4V$ Step	11				ns	typ	C
<b>Harmonic Distortion</b>								
2nd-Harmonic	$V_O = 2V_{PP}$ , $f = 20MHz$	-66	-64	-64	-64	dBc	min	B
3rd-Harmonic	$V_O = 2V_{PP}$ , $f = 20MHz$	-63	-61	-61	-61	dBc	min	B
Input Voltage Noise	$f > 100kHz$	6				nV/ $\sqrt{Hz}$	typ	C
Input Current Noise	$f > 100kHz$	2.6				pA/ $\sqrt{Hz}$	typ	C
<b>GAIN CONTROL</b>								
Gain Error	$A_{V_{MAX}} = +10V/V$ , $V_G = 1V$	$\pm 0.1$	<b><math>\pm 0.4</math></b>	$\pm 0.5$	$\pm 0.6$	dB	max	A
Gain Deviation	$A_{V_{MAX}} = +10V/V$ , $0 < V_G < 1$	$\pm 0.05$	<b><math>\pm 0.3</math></b>	$\pm 0.34$	$\pm 0.37$	dB	max	A
Gain Deviation	$A_{V_{MAX}} = +10V/V$ , $-0.8 < V_G < 1$	$\pm 1.06$	<b><math>\pm 1.9</math></b>	$\pm 2.1$	$\pm 2.2$	dB	max	A
Gain at $V_G = -0.9V$	Relative to max gain	-26	<b>-24</b>	-24	-23	dB	max	A
Gain Control Bias Current		22	<b>30</b>	35	37	$\mu$ A	max	A
Average Gain Control Bias Current Drift				$\pm 100$	$\pm 100$	nA/ $^{\circ}$ C	max	B
Gain Control Input Impedance		1.5    0.6				M $\Omega$    pF	typ	C
<b>DC PERFORMANCE</b>								
Input Offset Voltage	$A_{V_{MAX}} = +10V/V$ , $V_{CM} = 0V$ , $V_G = 1V$	$\pm 4$	<b><math>\pm 17</math></b>	$\pm 17.8$	$\pm 19$	mV	max	A
Average Input Offset Voltage Drift	$A_{V_{MAX}} = +10V/V$ , $V_{CM} = 0V$ , $V_G = 1V$			$\pm 30$	$\pm 30$	$\mu$ V/ $^{\circ}$ C	max	B
Input Bias Current	$A_{V_{MAX}} = +10V/V$ , $V_{CM} = 0V$ , $V_G = 1V$	19	<b>25</b>	29	31	$\mu$ A	max	A
Average Input Bias Current Drift	$A_{V_{MAX}} = +10V/V$ , $V_{CM} = 0V$ , $V_G = 1V$			$\pm 90$	$\pm 90$	nA/ $^{\circ}$ C	max	B
Input Offset Current	$A_{V_{MAX}} = +10V/V$ , $V_{CM} = 0V$ , $V_G = 1V$	$\pm 0.5$	<b><math>\pm 2.5</math></b>	$\pm 3.2$	$\pm 3.5$	$\mu$ A	max	A
Average Input Offset Current Drift	$A_{V_{MAX}} = +10V/V$ , $V_{CM} = 0V$ , $V_G = 1V$			$\pm 16$	$\pm 16$	nA/ $^{\circ}$ C	max	B
Max Current Through Gain Resistance		$\pm 2.6$	<b><math>\pm 2.55</math></b>	$\pm 2.55$	$\pm 2.5$	mA	max	B
<b>INPUT</b>								
Most Positive Common-Mode Input Voltage	$R_L = 100\Omega$	+1.6	<b>+1.6</b>	+1.6	+1.6	V	min	A
Most Negative Common-Mode Input Voltage	$R_L = 100\Omega$	-2.1	<b>-2.1</b>	-2.1	-2.1	V	max	A
Common-Mode Rejection Ratio	$V_{CM} = \pm 0.5V$	80	<b>65</b>	60	60	dB	min	A
<b>Input Impedance</b>								
Differential		1    1				M $\Omega$    pF	typ	C
Common-Mode		1    2				M $\Omega$    pF	typ	C

- (1) Test levels: (A) 100% tested at +25°C. Over temperature limits set by characterization and simulation. (B) Limits set by characterization and simulation. (C) Typical value only for information.
- (2) Junction temperature = ambient for +25°C tested specifications.
- (3) Junction temperature = ambient at low temperature limit; junction temperature = ambient +23°C at high temperature limit for over temperature specifications.

**ELECTRICAL CHARACTERISTICS:  $V_S = \pm 5V$  (continued)**At  $A_{VMAX} = +10V/V$ ,  $V_G = +1V$ ,  $R_F = 402\Omega$ ,  $R_G = 80\Omega$ , and  $R_L = 100\Omega$ , unless otherwise noted.

PARAMETER	CONDITIONS	VCA824				UNITS	MIN/ MAX	TEST LEVEL <sup>(1)</sup>
		TYP	MIN/MAX OVER TEMPERATURE					
		+25°C	+25°C <sup>(2)</sup>	0°C to 70°C <sup>(3)</sup>	-40°C to +85°C <sup>(3)</sup>			
<b>OUTPUT</b>								
Output Voltage Swing	$R_L = 1k\Omega$	$\pm 3.9$	<b><math>\pm 3.6</math></b>	$\pm 3.4$	$\pm 3.3$	V	min	A
	$R_L = 100\Omega$	$\pm 3.6$	<b><math>\pm 3.5</math></b>	$\pm 3.3$	$\pm 3.2$	V	min	A
Output Current	$V_O = 0V$ , $R_L = 10\Omega$	$\pm 90$	<b><math>\pm 60</math></b>	= 50	= 45	mA	min	A
Output Impedance	$A_{VMAX} = +10V/V$ , $f > 100kHz$	0.01				$\Omega$	typ	C
<b>POWER SUPPLY</b>								
Specified Operating Voltage		$\pm 5$				V	typ	C
Minimum Operating Voltage			$\pm 4$	$\pm 4$	$\pm 4$	V	min	B
Maximum Operating Voltage			<b><math>\pm 6</math></b>	$\pm 6$	$\pm 6$	V	max	A
Maximum Quiescent Current	$V_G = 0V$	36.5	<b>37.5</b>	38	38.5	mA	max	A
Minimum Quiescent Current	$V_G = 0V$	36.5	<b>35</b>	34.5	34	mA	max	A
Power-Supply Rejection Ratio (-PSRR)	$V_G = +1V$	-68	<b>-61</b>	-59	-58	dB	min	A
<b>THERMAL CHARACTERISTICS</b>								
Specified Operating Range D Package		-40 to +85				°C	typ	C
Thermal Resistance $\theta_{JA}$	Junction-to-Ambient							
DGS, MSOP-10		130				°C/W	typ	C
D, SO-14		80				°C/W	typ	C

**TYPICAL CHARACTERISTICS:  $V_S = \pm 5V$ , DC Parameters**

At  $T_A = +25^\circ C$ ,  $R_L = 100\Omega$ ,  $V_G = +1V$ , and  $V_{IN}$  = single-ended input on  $+V_{IN}$  with  $-V_{IN}$  at ground, unless otherwise noted.

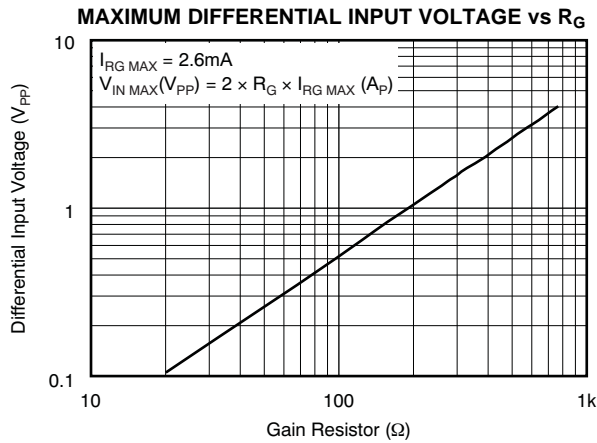

Figure 1.

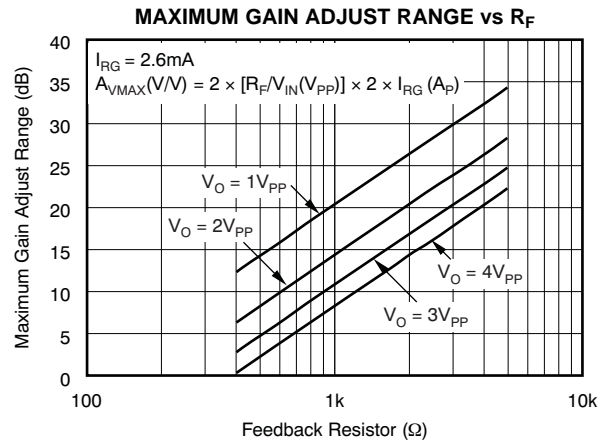

Figure 2.

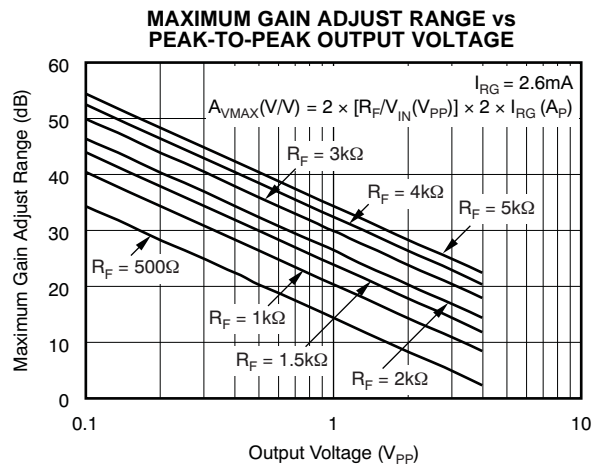

Figure 3.

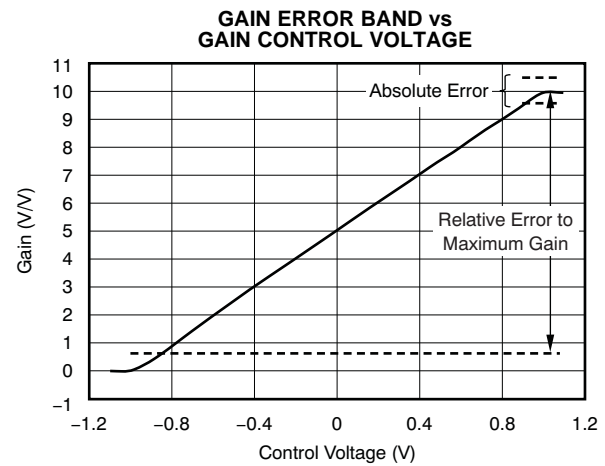

Figure 4.

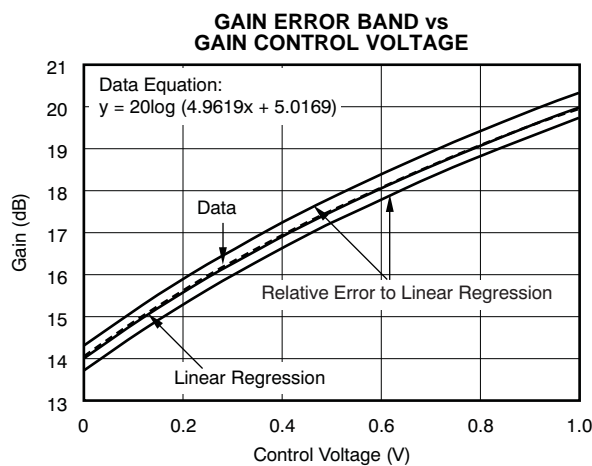

Figure 5.

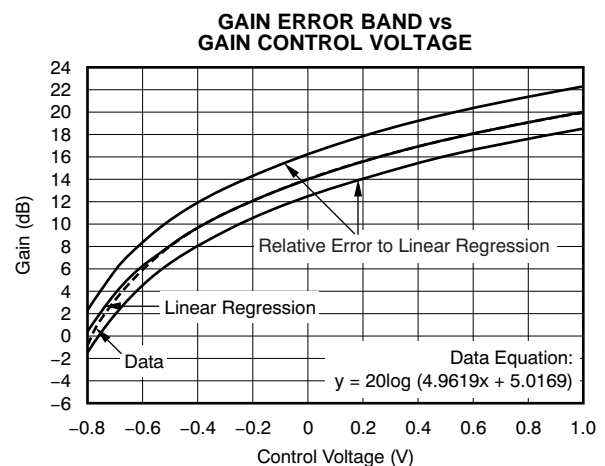

Figure 6.

**TYPICAL CHARACTERISTICS:  $V_S = \pm 5V$ , DC and Power-Supply Parameters**

At  $T_A = +25^\circ C$ ,  $R_L = 100\Omega$ ,  $V_G = +1V$ , and  $V_{IN}$  = single-ended input on  $+V_{IN}$  with  $-V_{IN}$  at ground, unless otherwise noted.

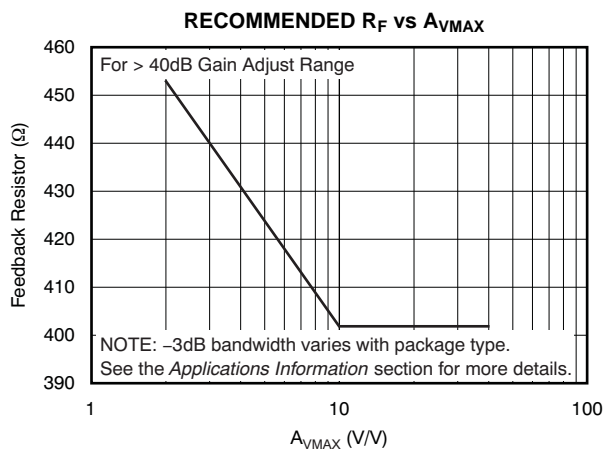

Figure 7.

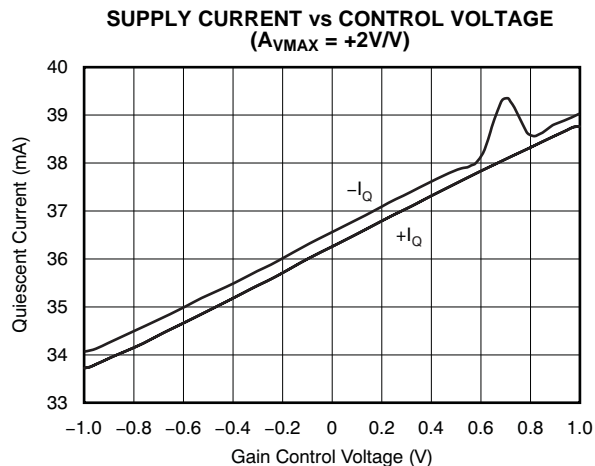

Figure 8.

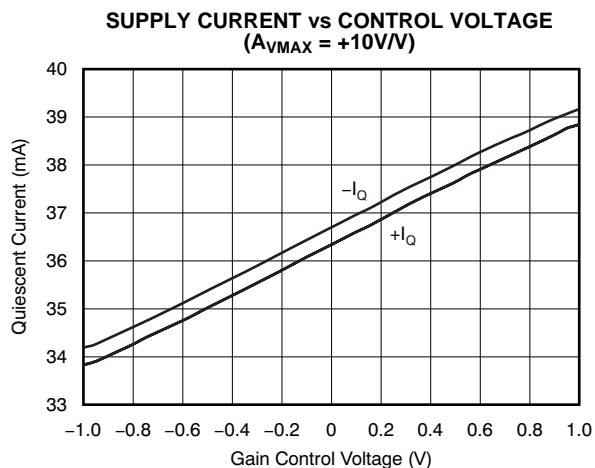

Figure 9.

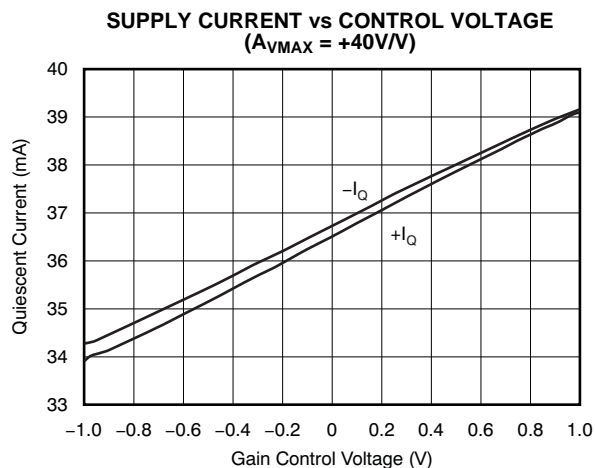

Figure 10.

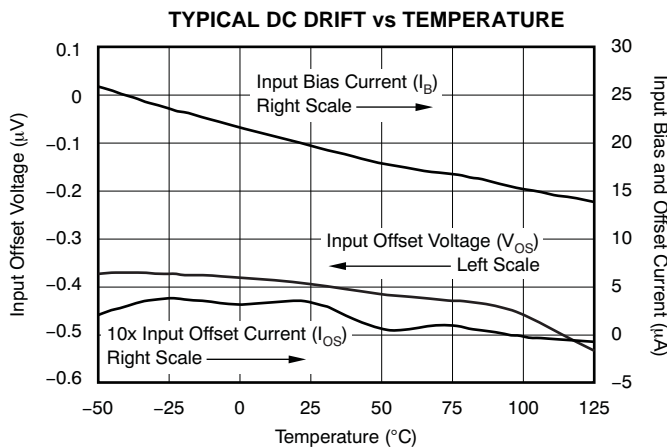

Figure 11.

**TYPICAL CHARACTERISTICS:  $V_S = \pm 5V$ ,  $A_{VMAX} = +2V/V$**

At  $T_A = +25^\circ C$ ,  $R_L = 100\Omega$ ,  $R_F = 453\Omega$ ,  $R_G = 453\Omega$ ,  $V_G = +1V$ ,  $V_{IN}$  = single-ended input on  $+V_{IN}$  with  $-V_{IN}$  at ground, and SO-14 package, unless otherwise noted.

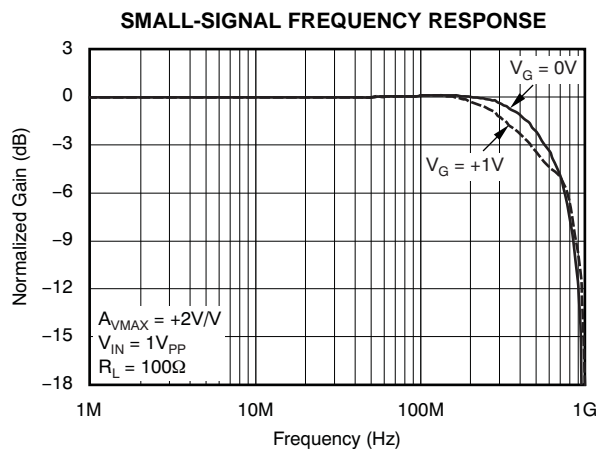

Figure 12.

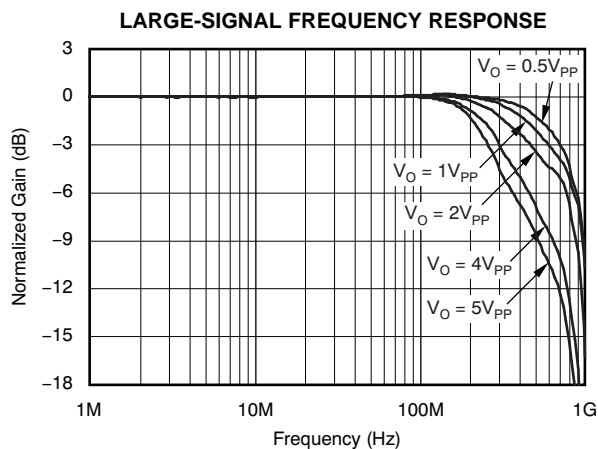

Figure 13.

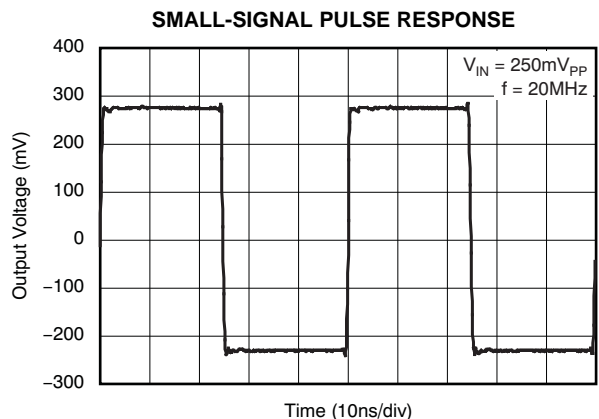

Figure 14.

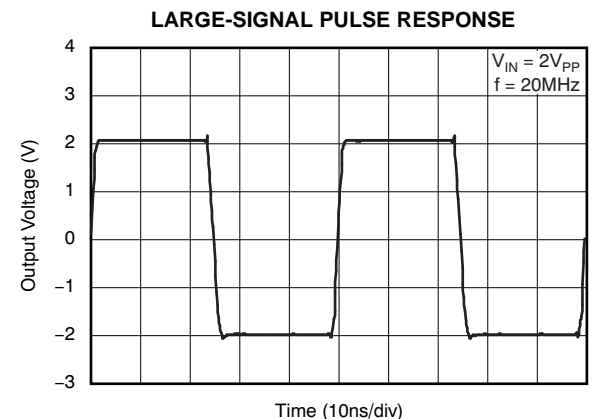

Figure 15.

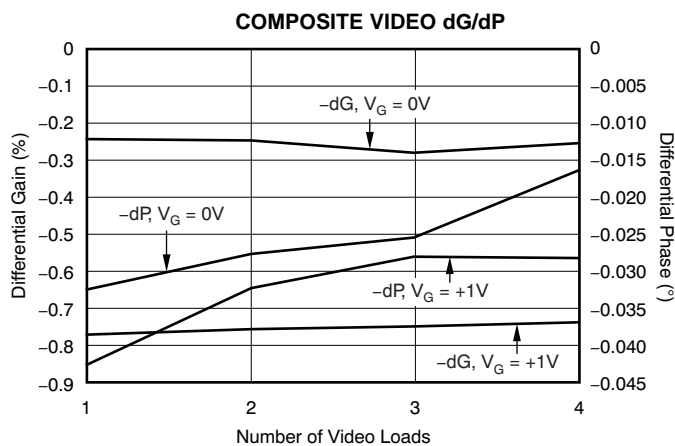

Figure 16.

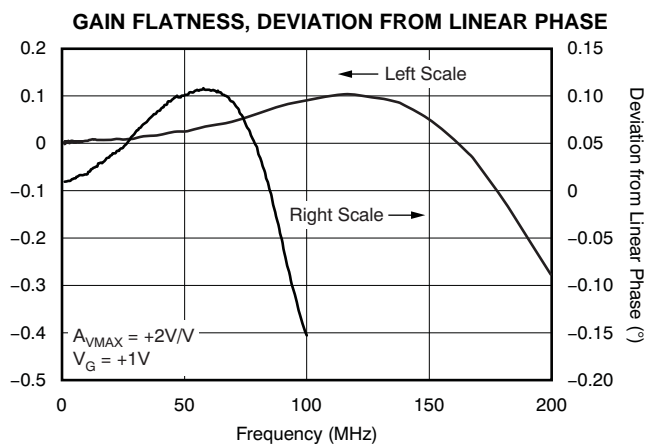

Figure 17.

**TYPICAL CHARACTERISTICS:  $V_S = \pm 5V$ ,  $A_{V_{MAX}} = +2V/V$  (continued)**

At  $T_A = +25^\circ C$ ,  $R_L = 100\Omega$ ,  $R_F = 453\Omega$ ,  $R_G = 453\Omega$ ,  $V_G = +1V$ ,  $V_{IN}$  = single-ended input on  $+V_{IN}$  with  $-V_{IN}$  at ground, and SO-14 package, unless otherwise noted.

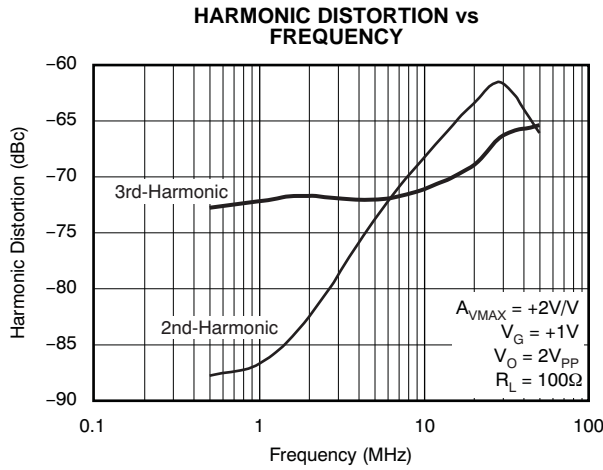

Figure 18.

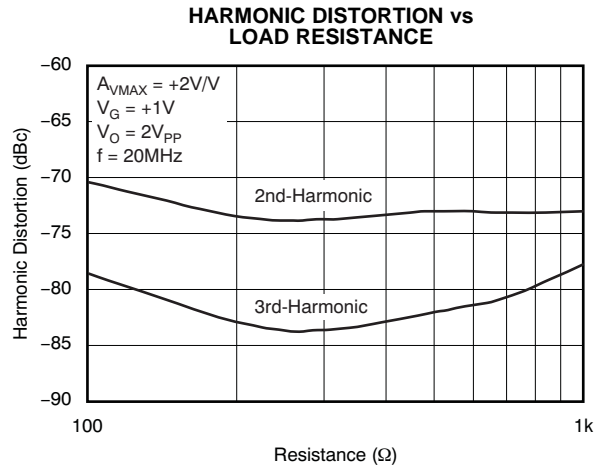

Figure 19.

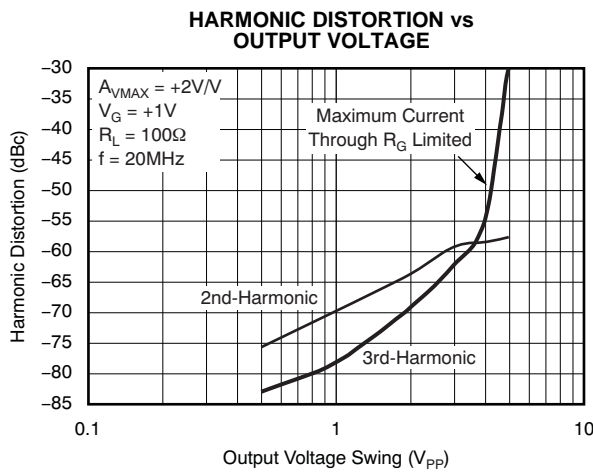

Figure 20.

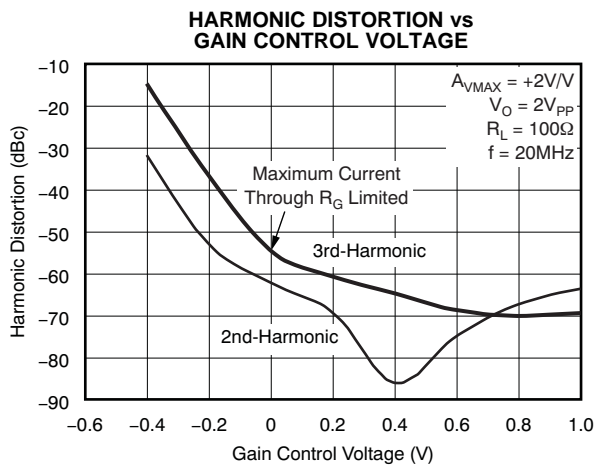

Figure 21.

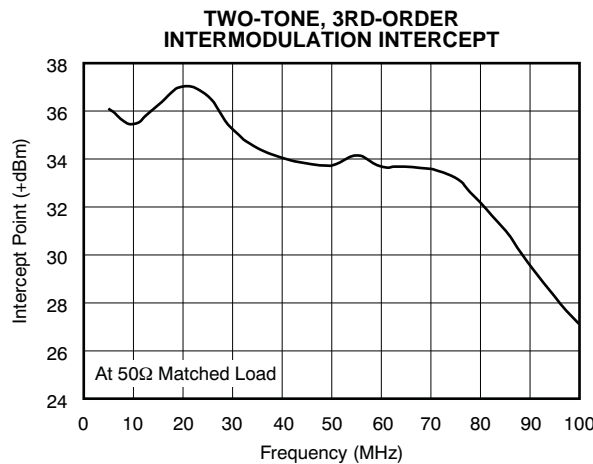

Figure 22.

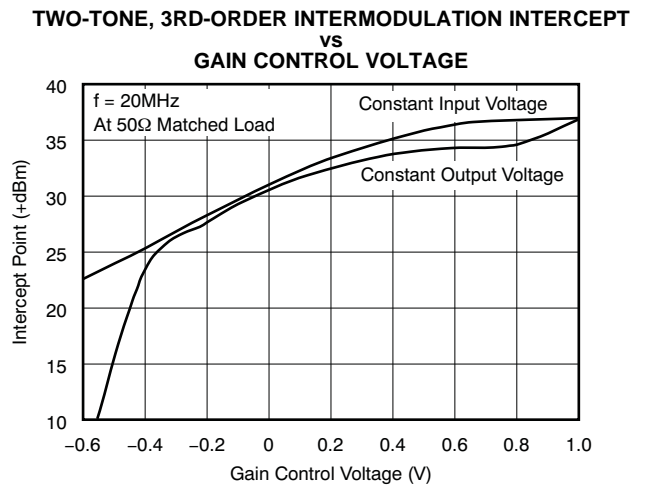

Figure 23.



**TYPICAL CHARACTERISTICS:  $V_S = \pm 5V$ ,  $A_{V_{MAX}} = +2V/V$  (continued)**

At  $T_A = +25^\circ C$ ,  $R_L = 100\Omega$ ,  $R_F = 453\Omega$ ,  $R_G = 453\Omega$ ,  $V_G = +1V$ ,  $V_{IN} =$  single-ended input on  $+V_{IN}$  with  $-V_{IN}$  at ground, and SO-14 package, unless otherwise noted.

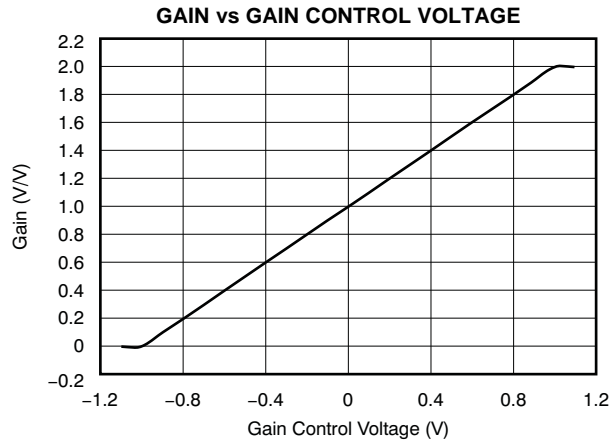

Figure 24.

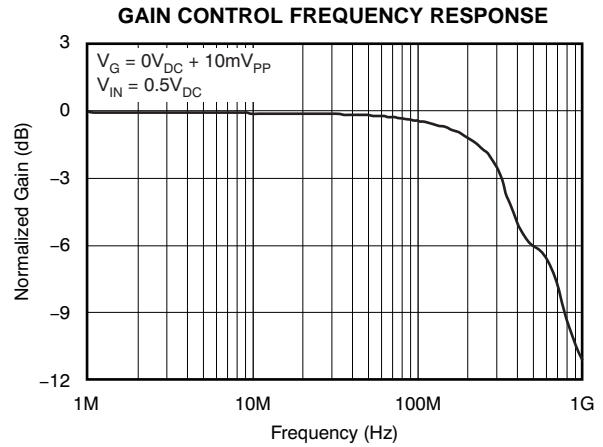

Figure 25.

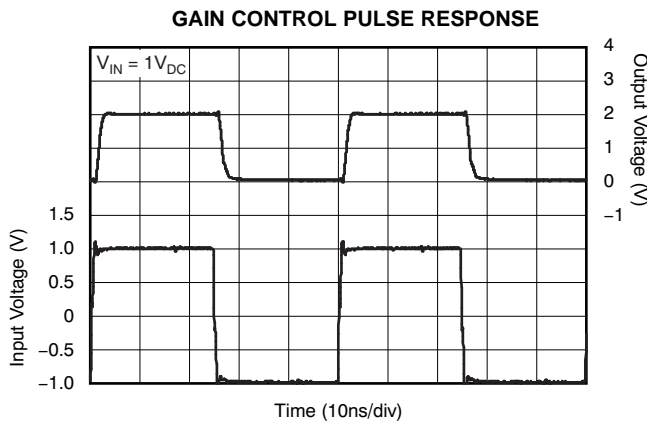

Figure 26.

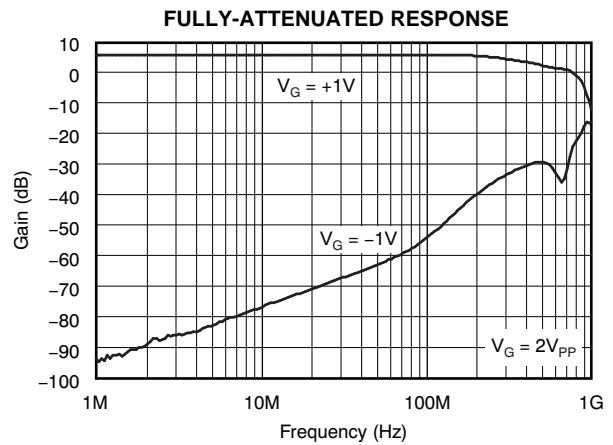

Figure 27.

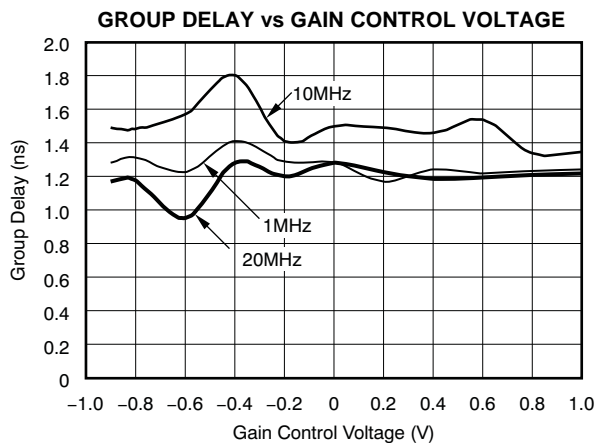

Figure 28.

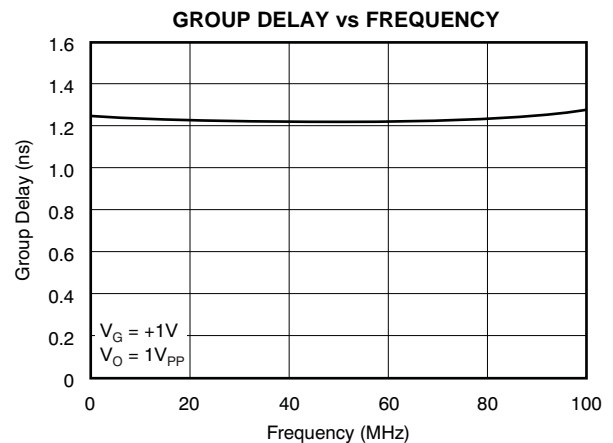

Figure 29.

**TYPICAL CHARACTERISTICS:  $V_S = \pm 5V$ ,  $A_{VMAX} = +2V/V$  (continued)**

At  $T_A = +25^\circ C$ ,  $R_L = 100\Omega$ ,  $R_F = 453\Omega$ ,  $R_G = 453\Omega$ ,  $V_G = +1V$ ,  $V_{IN}$  = single-ended input on  $+V_{IN}$  with  $-V_{IN}$  at ground, and SO-14 package, unless otherwise noted.

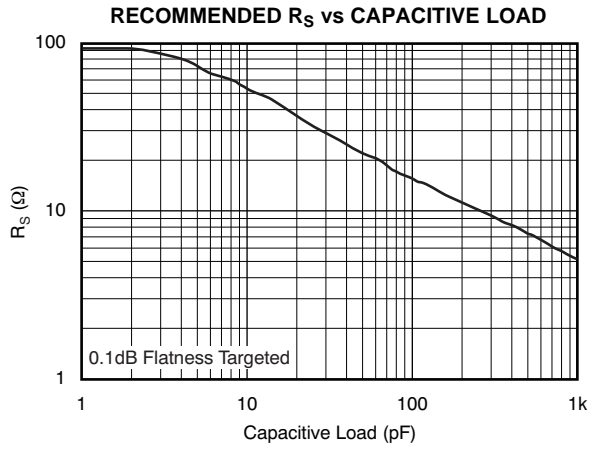

Figure 30.

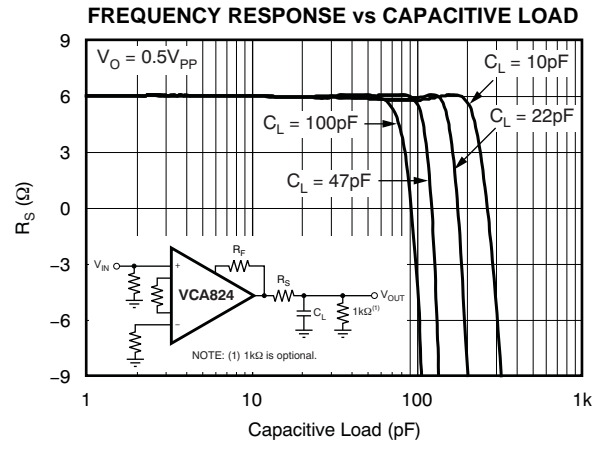

Figure 31.

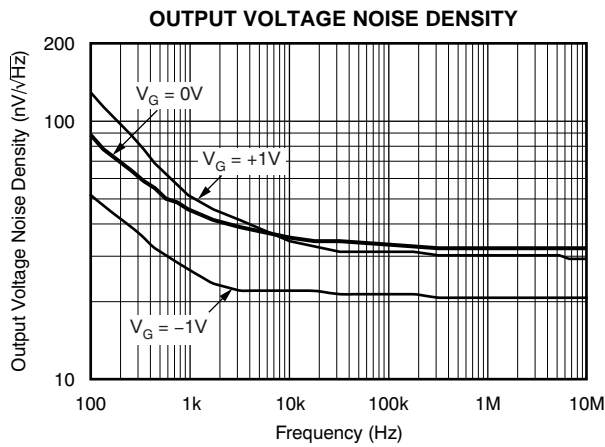

Figure 32.

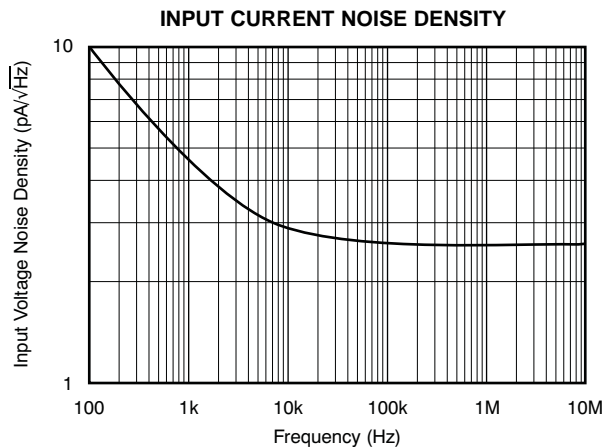

Figure 33.

**TYPICAL CHARACTERISTICS:  $V_S = \pm 5V$ ,  $A_{VMAX} = +10V/V$**

At  $T_A = +25^\circ C$ ,  $R_L = 100\Omega$ ,  $R_F = 402\Omega$ ,  $R_G = 80\Omega$ ,  $V_G = +1V$ , and  $V_{IN}$  = single-ended input on  $+V_{IN}$  with  $-V_{IN}$  at ground, unless otherwise noted.

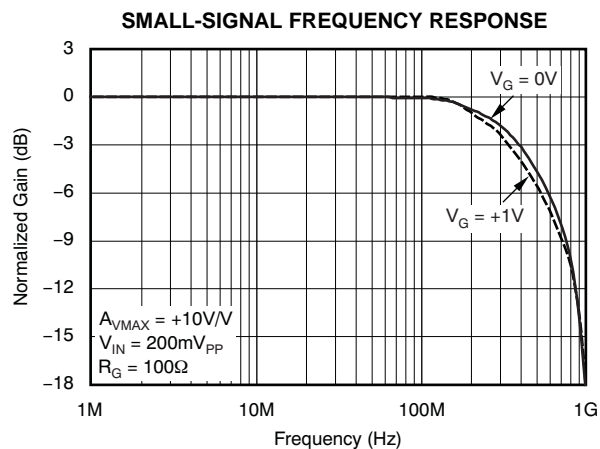

Figure 34.

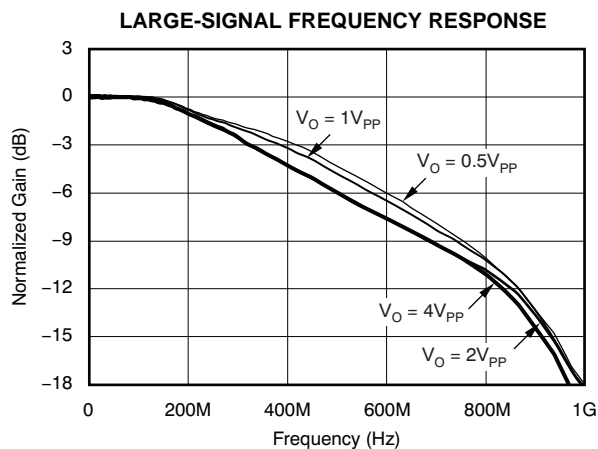

Figure 35.

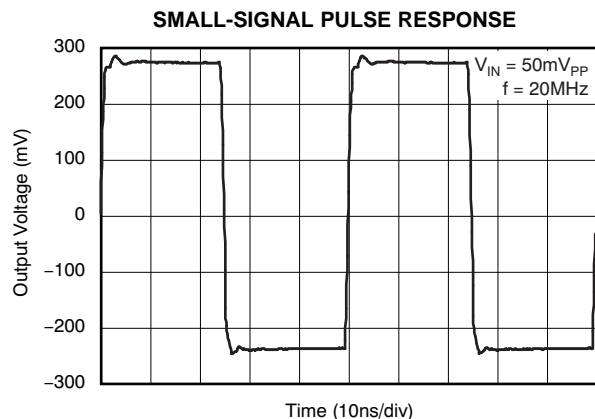

Figure 36.

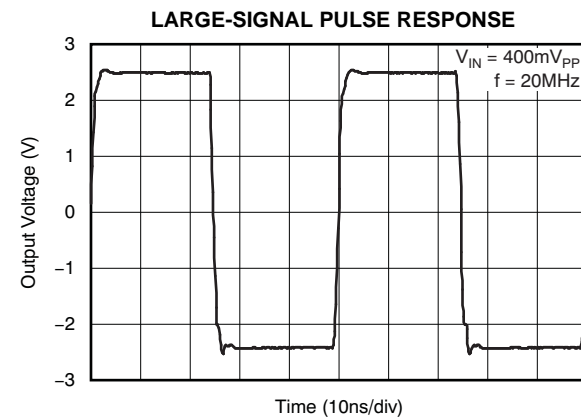

Figure 37.

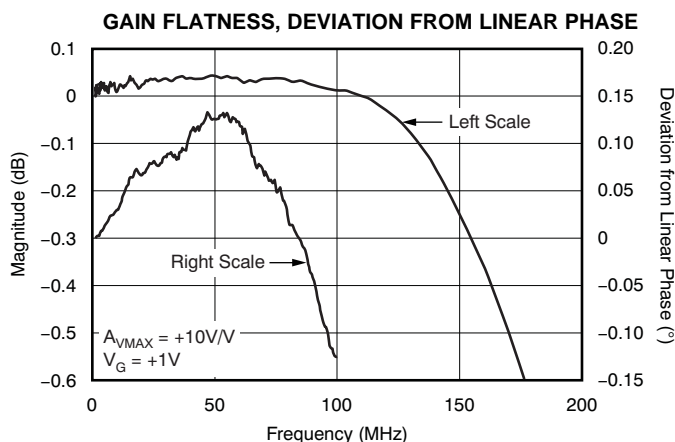

Figure 38.

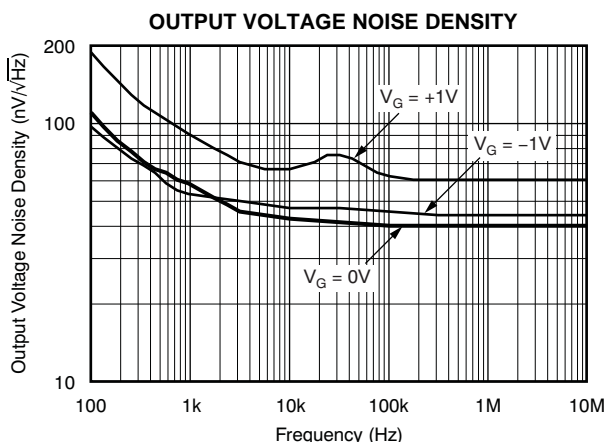

Figure 39.

**TYPICAL CHARACTERISTICS:  $V_S = \pm 5V$ ,  $A_{VMAX} = +10V/V$  (continued)**

At  $T_A = +25^\circ C$ ,  $R_L = 100\Omega$ ,  $R_F = 402\Omega$ ,  $R_G = 80\Omega$ ,  $V_G = +1V$ , and  $V_{IN}$  = single-ended input on  $+V_{IN}$  with  $-V_{IN}$  at ground, unless otherwise noted.

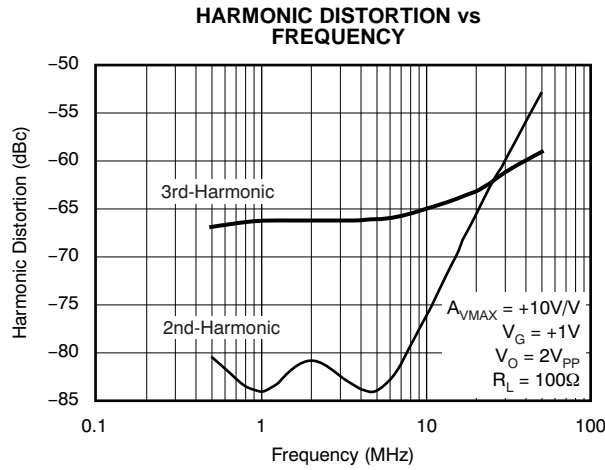

Figure 40.

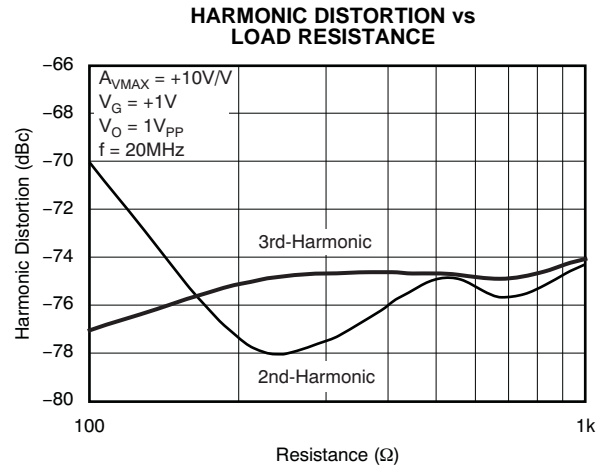

Figure 41.

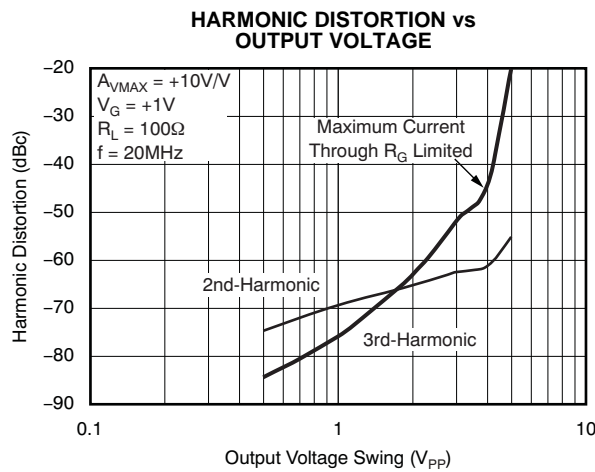

Figure 42.

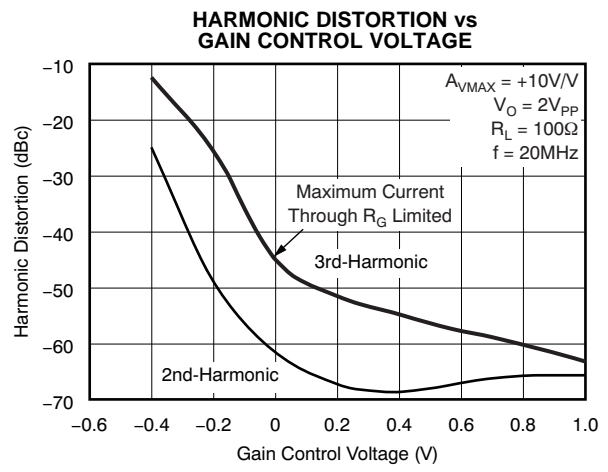

Figure 43.

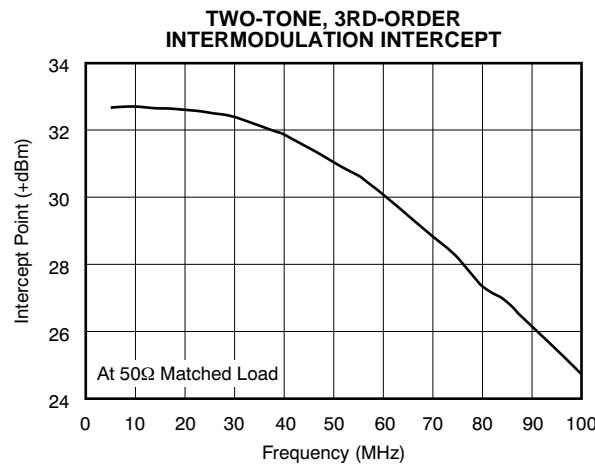

Figure 44.

**TWO-TONE, 3RD-ORDER INTERMODULATION INTERCEPT vs GAIN CONTROL VOLTAGE**

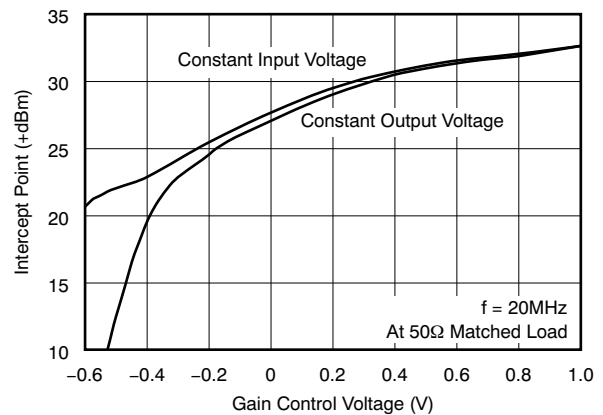

Figure 45.

**TYPICAL CHARACTERISTICS:  $V_S = \pm 5V$ ,  $A_{VMAX} = +10V/V$  (continued)**

At  $T_A = +25^\circ C$ ,  $R_L = 100\Omega$ ,  $R_F = 402\Omega$ ,  $R_G = 80\Omega$ ,  $V_G = +1V$ , and  $V_{IN}$  = single-ended input on  $+V_{IN}$  with  $-V_{IN}$  at ground, unless otherwise noted.

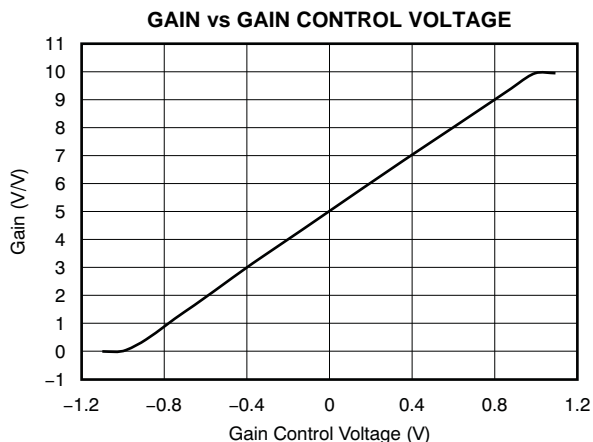

Figure 46.

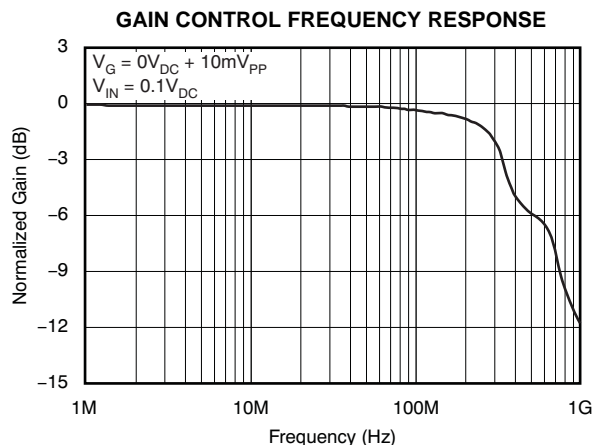

Figure 47.

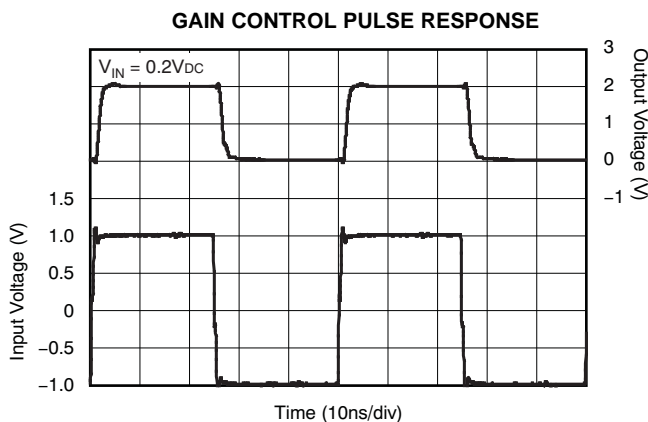

Figure 48.

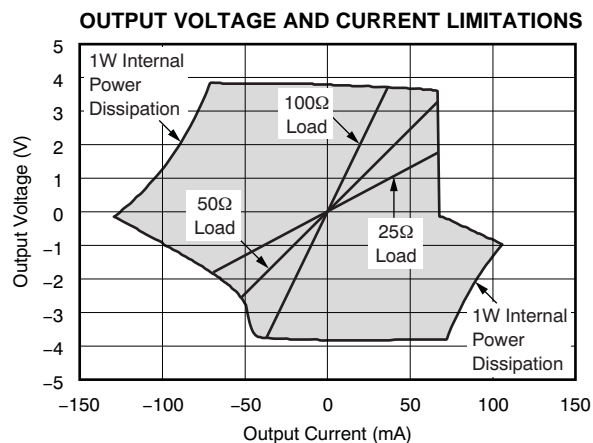

Figure 49.

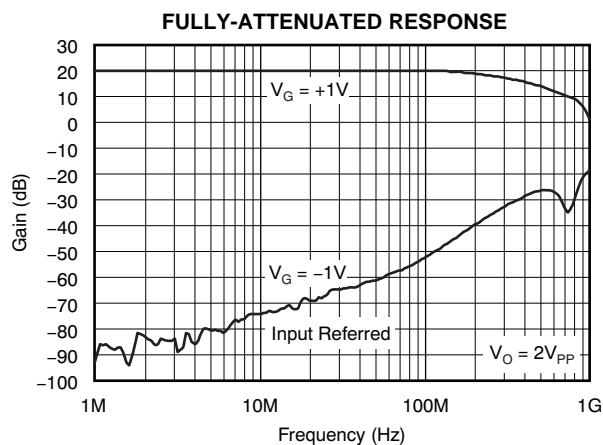

Figure 50.

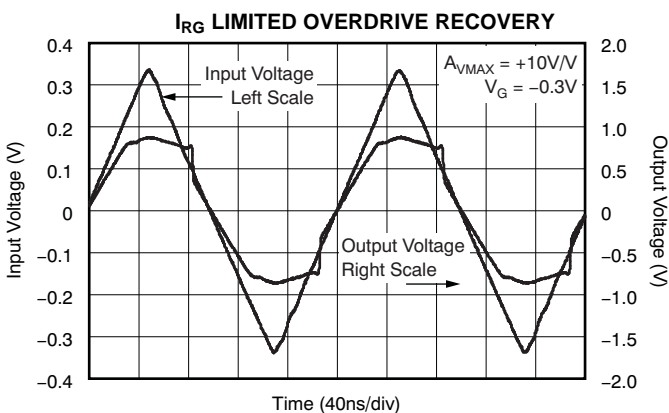

Figure 51.

**TYPICAL CHARACTERISTICS:  $V_S = \pm 5V$ ,  $A_{VMAX} = +10V/V$  (continued)**

At  $T_A = +25^\circ C$ ,  $R_L = 100\Omega$ ,  $R_F = 402\Omega$ ,  $R_G = 80\Omega$ ,  $V_G = +1V$ , and  $V_{IN}$  = single-ended input on  $+V_{IN}$  with  $-V_{IN}$  at ground, unless otherwise noted.

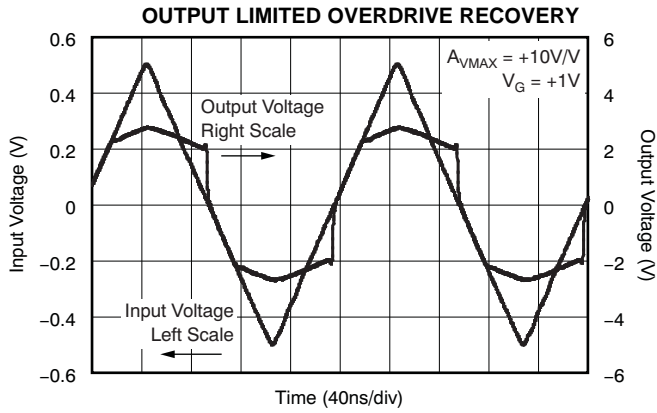

Figure 52.

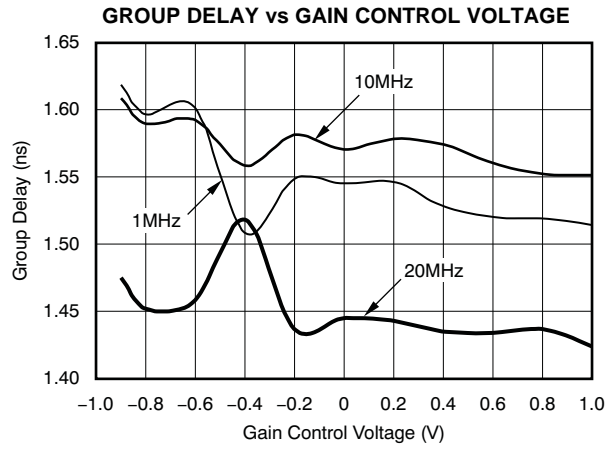

Figure 53.

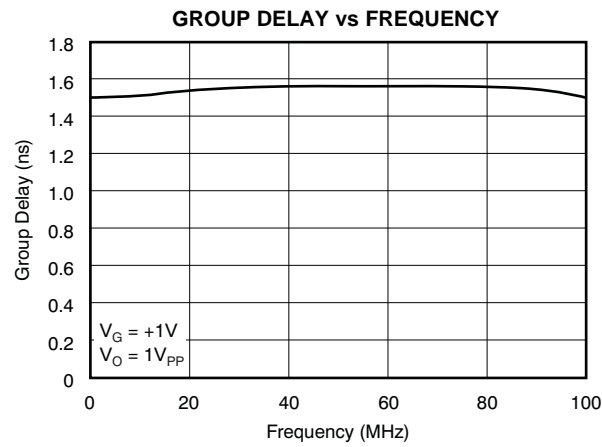

Figure 54.

**TYPICAL CHARACTERISTICS:  $V_S = \pm 5V$ ,  $A_{VMAX} = +40V/V$**

At  $T_A = +25^\circ C$ ,  $R_L = 100\Omega$ ,  $R_F = 402\Omega$ ,  $R_G = 18\Omega$ ,  $V_G = +1V$ ,  $V_{IN}$  = single-ended input on  $+V_{IN}$  with  $-V_{IN}$  at ground, and SO-14 package, unless otherwise noted.

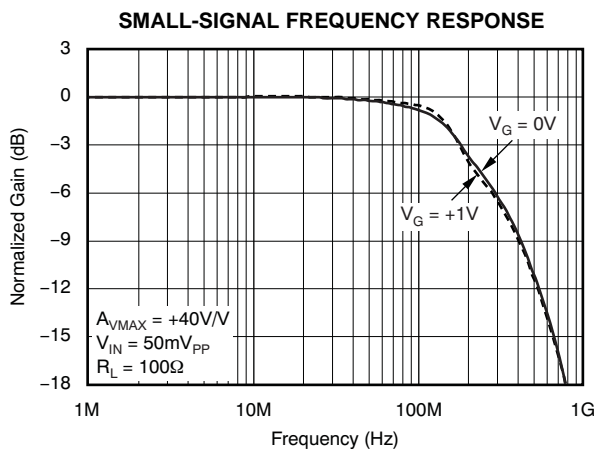

Figure 55.

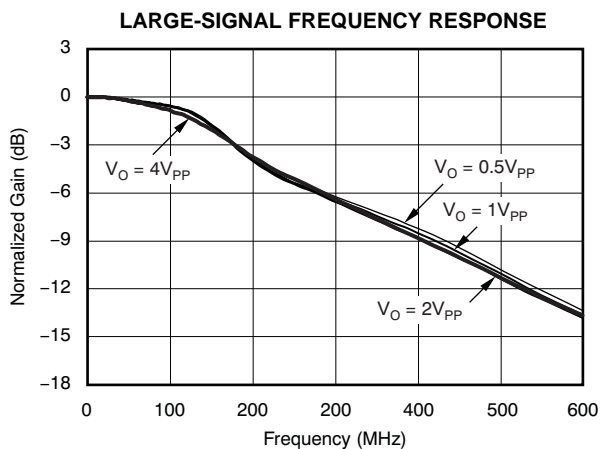

Figure 56.

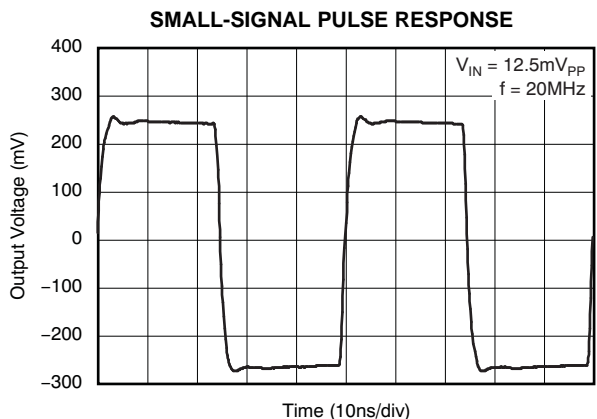

Figure 57.

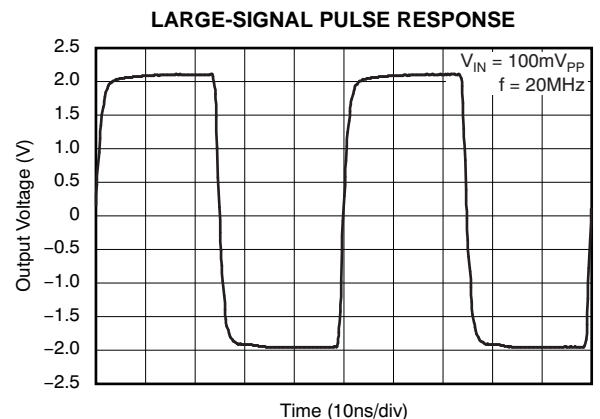

Figure 58.

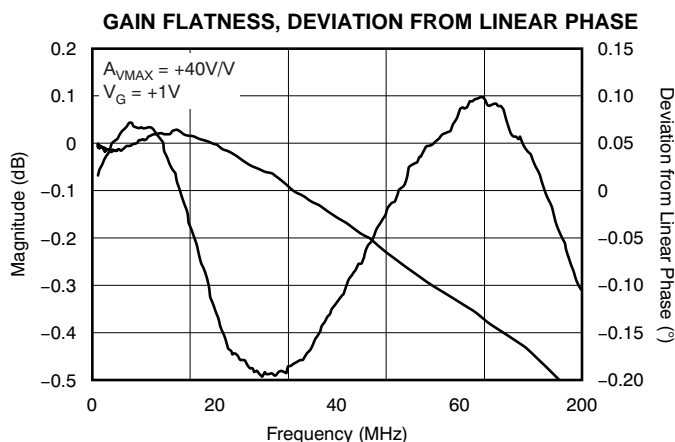

Figure 59.

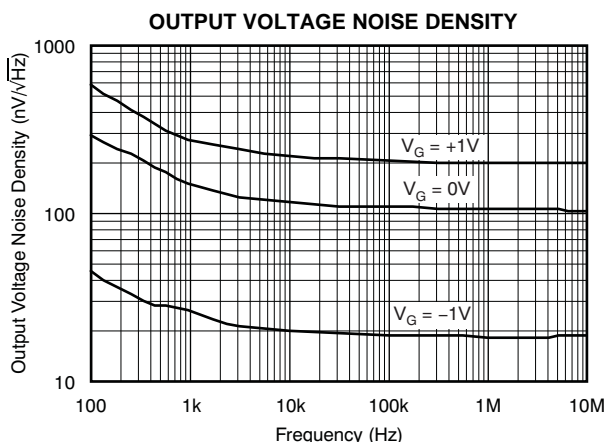

Figure 60.

**TYPICAL CHARACTERISTICS:  $V_S = \pm 5V$ ,  $A_{VMAX} = +40V/V$  (continued)**

At  $T_A = +25^\circ C$ ,  $R_L = 100\Omega$ ,  $R_F = 402\Omega$ ,  $R_G = 18\Omega$ ,  $V_G = +1V$ ,  $V_{IN} =$  single-ended input on  $+V_{IN}$  with  $-V_{IN}$  at ground, and SO-14 package, unless otherwise noted.

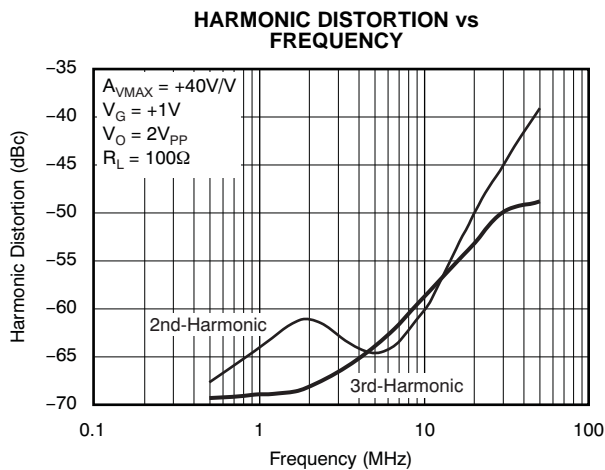

Figure 61.

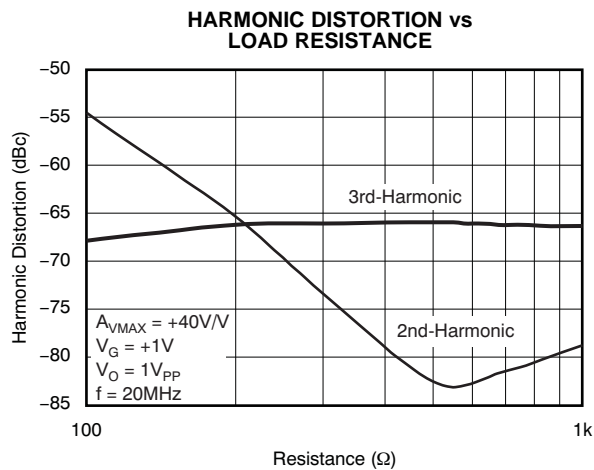

Figure 62.

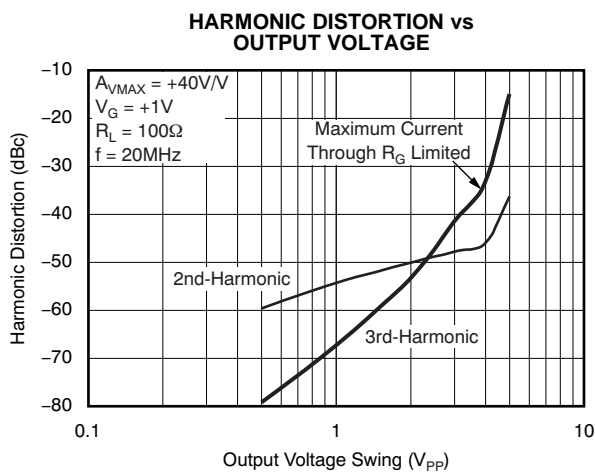

Figure 63.

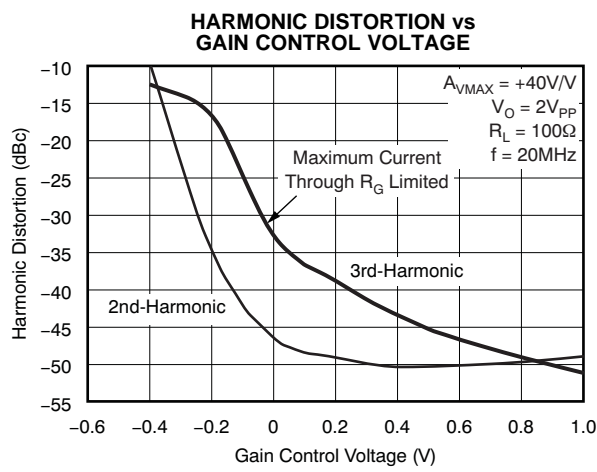

Figure 64.

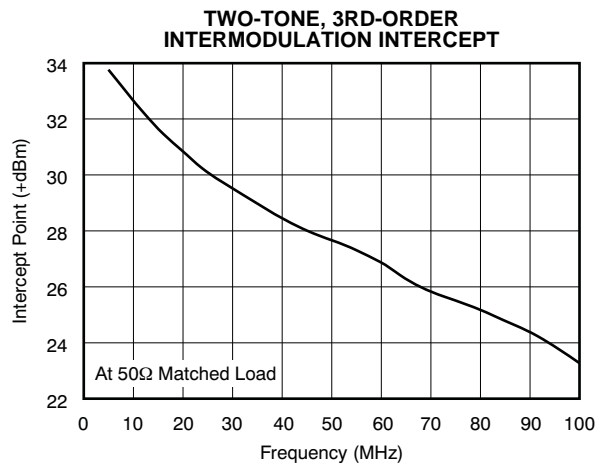

Figure 65.

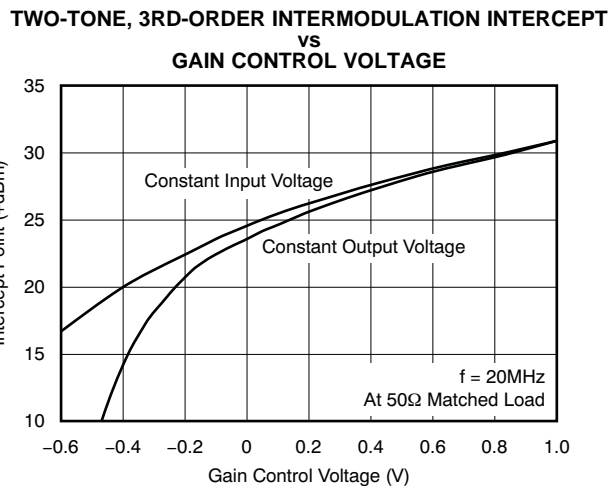

Figure 66.



**TYPICAL CHARACTERISTICS:  $V_S = \pm 5V$ ,  $A_{VMAX} = +40V/V$  (continued)**

At  $T_A = +25^\circ C$ ,  $R_L = 100\Omega$ ,  $R_F = 402\Omega$ ,  $R_G = 18\Omega$ ,  $V_G = +1V$ ,  $V_{IN} =$  single-ended input on  $+V_{IN}$  with  $-V_{IN}$  at ground, and SO-14 package, unless otherwise noted.

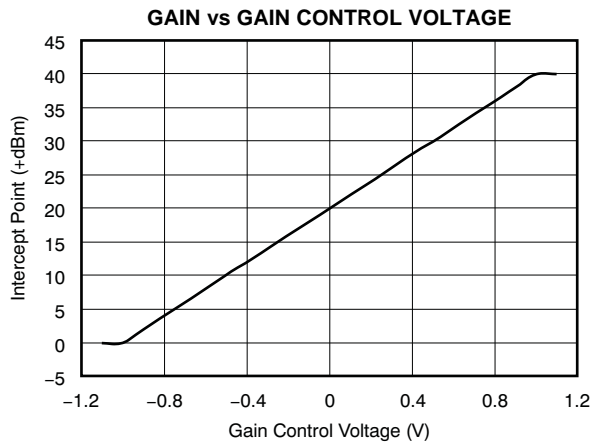

Figure 67.

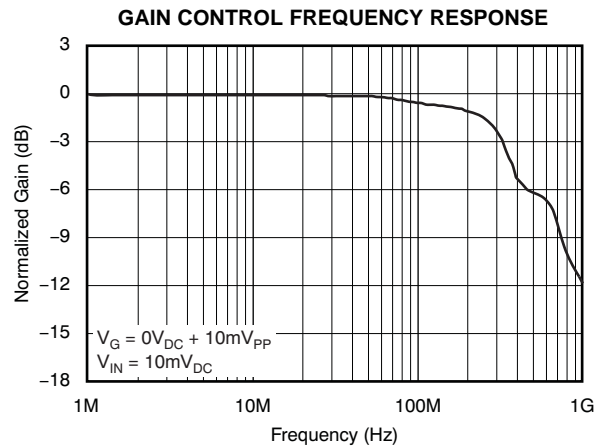

Figure 68.

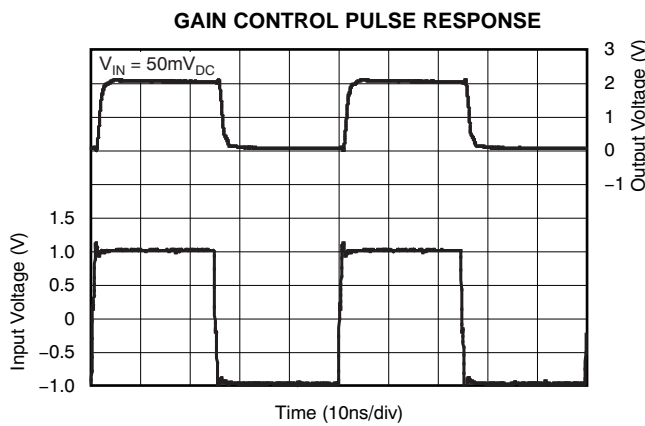

Figure 69.

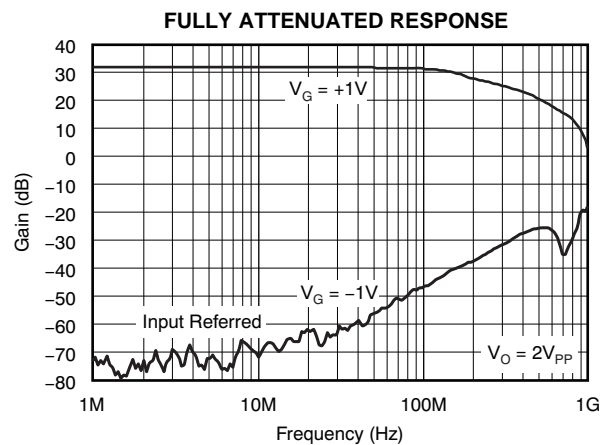

Figure 70.

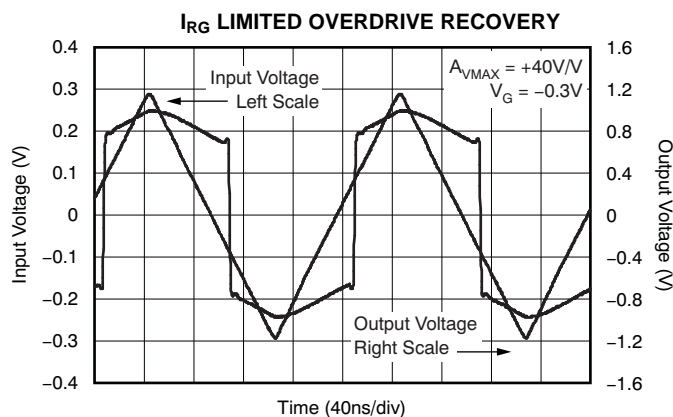

Figure 71.

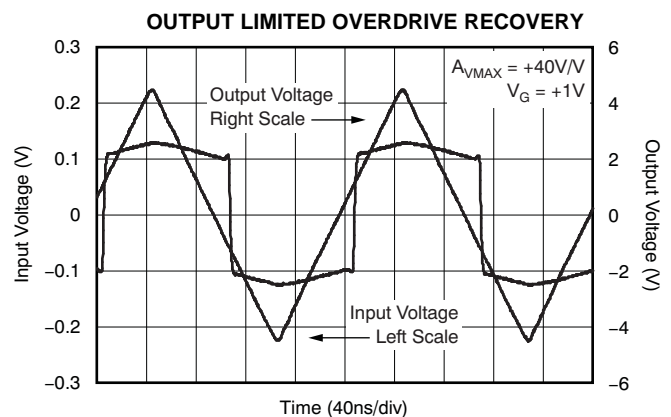

Figure 72.

**TYPICAL CHARACTERISTICS:  $V_S = \pm 5V$ ,  $A_{V_{MAX}} = +40V/V$  (continued)**

At  $T_A = +25^\circ C$ ,  $R_L = 100\Omega$ ,  $R_F = 402\Omega$ ,  $R_G = 18\Omega$ ,  $V_G = +1V$ ,  $V_{IN}$  = single-ended input on  $+V_{IN}$  with  $-V_{IN}$  at ground, and SO-14 package, unless otherwise noted.

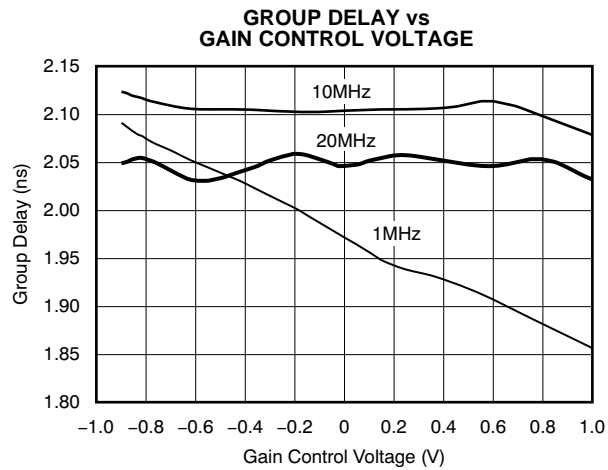

Figure 73.

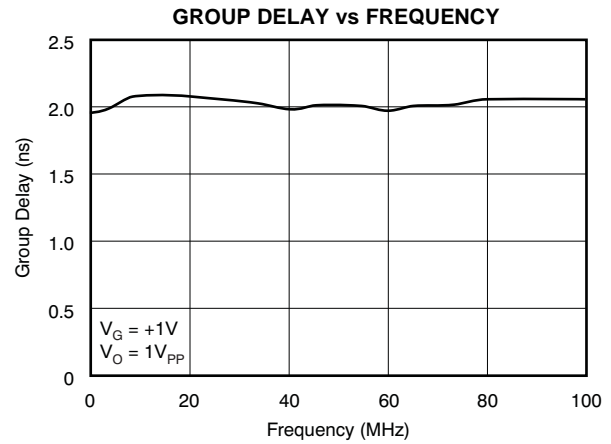

Figure 74.

## APPLICATION INFORMATION

### WIDEBAND VARIABLE GAIN AMPLIFIER OPERATION

The VCA824 provides an exceptional combination of high output power capability with a wideband, greater than 40dB gain adjust range, linear in V/V variable gain amplifier. The VCA824 input stage places the transconductance element between two input buffers, using the output currents as the forward signal. As the differential input voltage rises, a signal current is generated through the gain element. This current is then mirrored and gained by a factor of two before reaching the multiplier. The other input of the multiplier is the voltage gain control pin,  $V_G$ . Depending on the voltage present on  $V_G$ , up to two times the gain current is provided to the transimpedance output stage. The transimpedance output stage is a current-feedback amplifier providing high output current capability and high slew rate, 2500V/ $\mu$ s. This exceptional full-power performance comes at the price of relatively high quiescent current (36.5mA), but low input voltage noise for this type of architecture (6nV/ $\sqrt$ Hz).

Figure 75 shows the dc-coupled, gain of +10V/V, dual power-supply circuit used as the basis of the  $\pm$ 5V Electrical Characteristics and Typical Characteristics.

For test purposes, the input impedance is set to 50 $\Omega$  with a resistor to ground and the output impedance is set to 50 $\Omega$  with a series output resistor. Voltage swings reported in the Electrical Characteristics table are taken directly at the input and output pins, while output power (dBm) is at the matched 50 $\Omega$  load. For the circuit in Figure 75, the total effective load is 100 $\Omega$  || 1k $\Omega$ . Note that for the SO-14 package, there is a ground pin, GND (pin 11). For the SO-14 package, this pin must be connected to ground through a 20 $\Omega$  resistor in order to avoid possible oscillations of the output stage. In the MSOP-10 package, this pin is internally connected and does not require such precaution. An X2Y<sup>®</sup> capacitor has been used for power-supply bypassing. The combination of low inductance, high resonance frequency, and integration of three capacitors in one package (two capacitors to ground and one across the supplies) enables the VCA824 to achieve the low second-harmonic distortion reported in the Electrical Characteristics table. More information on how the VCA824 operates can be found in the Operating Suggestions section.

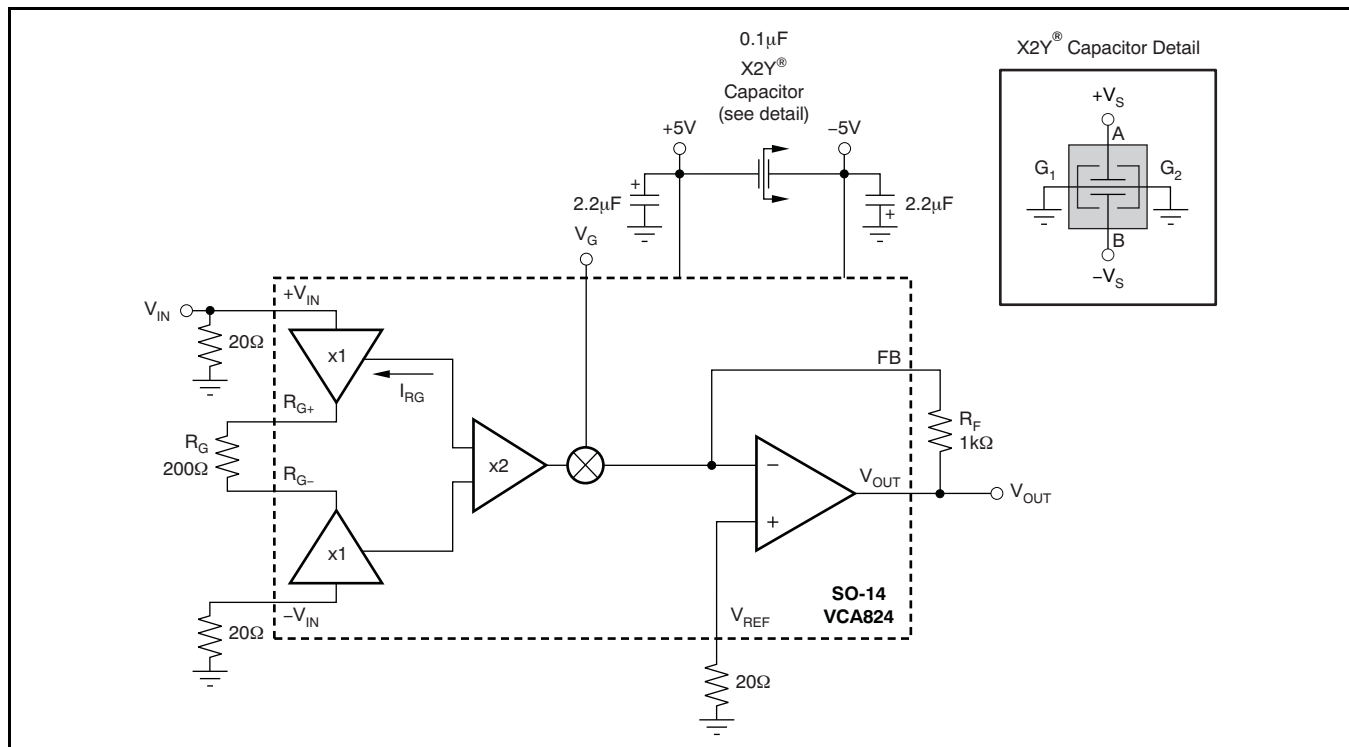

Figure 75. DC-Coupled,  $A_{V_{MAX}} = +10V/V$ , Bipolar Supply Specification and Test Circuit

### FOUR-QUADRANT MULTIPLIER

A four-quadrant multiplier can easily be implemented using the VCA824. By placing a resistor between FB and  $V_{IN}$ , the transfer function depends upon both  $V_{IN}$  and  $V_G$ , as shown in Equation 1.

$$V_{OUT} = \frac{R_F}{R_G} \times V_G \times V_{IN} + \left( \frac{R_F}{R_G} - \frac{R_F}{R_1} \right) \times V_{IN} \tag{1}$$

Setting  $R_1$  to equal  $R_G$ , the term that depends only on  $V_{IN}$  drops out of the equation, leaving only the term that depends on both  $V_G$  and  $V_{IN}$ .  $V_{OUT}$  then follows Equation 2.

$$V_{OUT} = \frac{R_F}{R_G} \times V_{IN} \times V_G \tag{2}$$

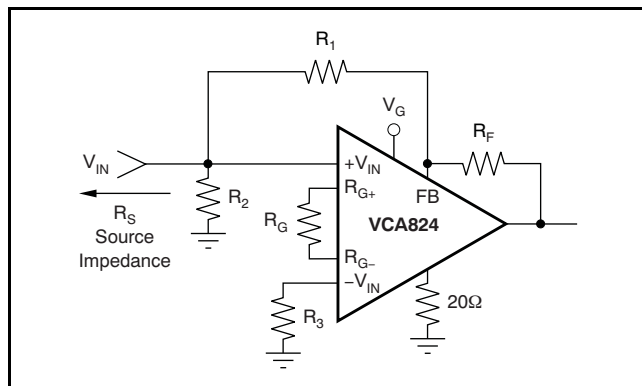

Figure 76. Four-Quadrant Multiplier Circuit

Figure 77 illustrates the behavior of this circuit. Keeping the input amplitude of a 1MHz signal constant and varying the  $V_G$  voltage (100kHz, 2V<sub>PP</sub>) gives the modulated output voltage shown in Figure 77.

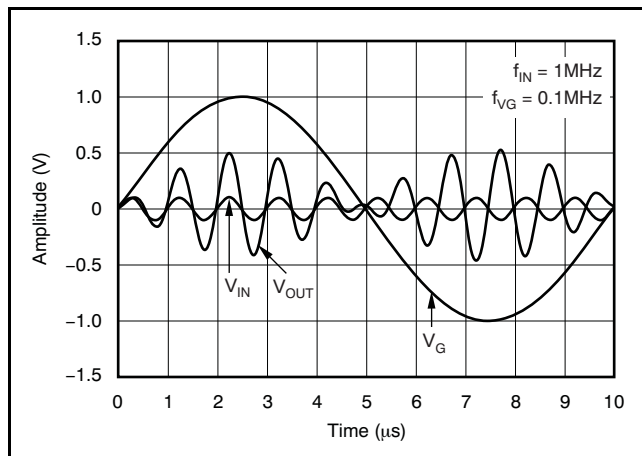

Figure 77. Modulated Output Signal of the 4-Quadrant Multiplier Circuit

### DIFFERENCE AMPLIFIER

Because both inputs of the VCA824 are high-impedance, a difference amplifier can be implemented without any major problem. Figure 78 shows this implementation. This circuit provides excellent common-mode rejection ratio (CMRR) as long as the input is within the CMRR range of  $-2.1V$  to  $+1.6V$ . Note that this circuit does not make use of the gain control pin,  $V_G$ . Also, it is recommended to choose  $R_S$  such that the pole formed by  $R_S$  and the parasitic input capacitance does not limit the bandwidth of the circuit. Figure 79 shows the common-mode rejection ratio for this circuit implemented in a gain of  $+10V/V$  for  $V_G = +1V$ . Note that because the gain control voltage is fixed and is normally set to  $+1V$ , the feedback element can be reduced in order to increase the bandwidth. When reducing the feedback element, make sure that the VCA824 is not limited by common-mode input voltage, the current flowing through  $R_G$ , or any other limitation described in this data sheet.

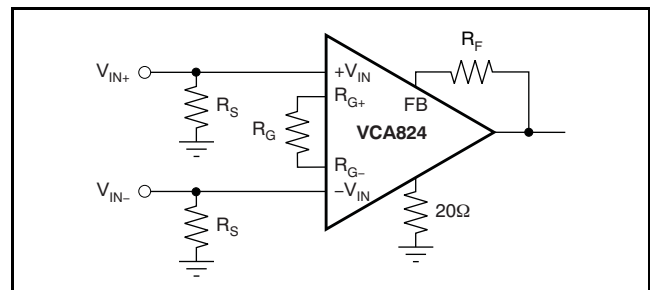

Figure 78. Difference Amplifier

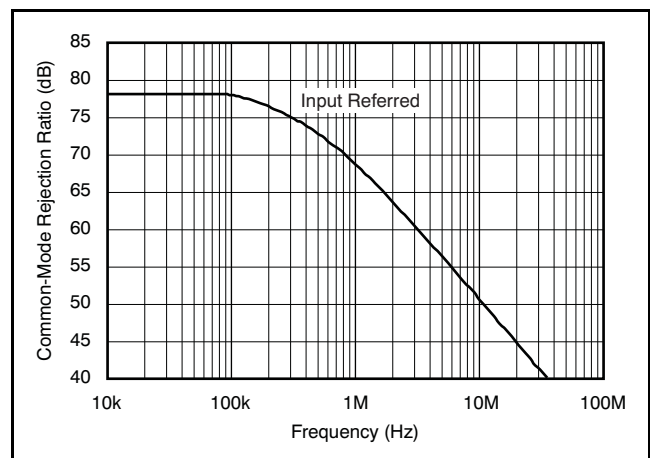

Figure 79. Common-Mode Rejection Ratio

### DIFFERENTIAL EQUALIZER

If the application requires frequency shaping (the transition from one gain to another), the VCA824 can be used advantageously because its architecture allows the application to isolate the input from the gain setting elements. Figure 80 shows an implementation of such a configuration. The transfer function is shown in Equation 3.

$$G = 2 \times \frac{R_F}{R_G} \times \frac{1 + sR_G C_1}{1 + sR_1 C_1} \quad (3)$$

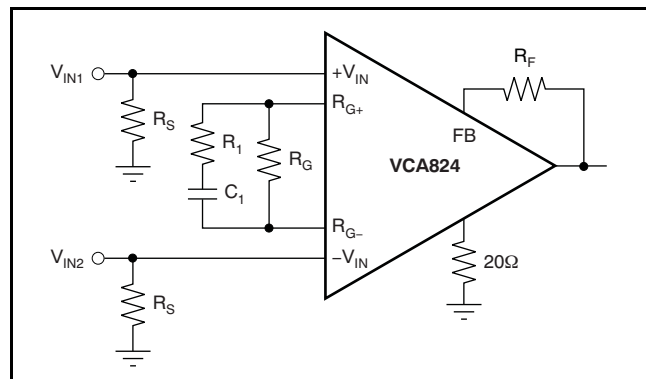

Figure 80. Differential Equalizer

This transfer function has one pole,  $P_1$  (located at  $R_G C_1$ ), and one zero,  $Z_1$  (located at  $R_1 C_1$ ). When equalizing an RC load,  $R_L$  and  $C_L$ , compensate the pole added by the load located at  $R_L C_L$  with the zero  $Z_1$ . Knowing  $R_L$ ,  $C_L$ , and  $R_G$  allows the user to select  $C_1$  as a first step and then calculate  $R_1$ . Using  $R_L = 75\Omega$ ,  $C_L = 100\text{pF}$  and wanting the VCA824 to operate at a gain of  $+2V/V$ , which gives  $R_F = R_G = 453\text{k}\Omega$ , allows the user to select  $C_1 = 15.5\text{pF}$  to ensure a positive value for the resistor  $R_1$ . With all these values known, to achieve greater than 300MHz bandwidth,  $R_1$  can be calculated to be  $20\Omega$ . Figure 81 shows the frequency response for both the initial, unequalized frequency response and the resulting equalized frequency response.

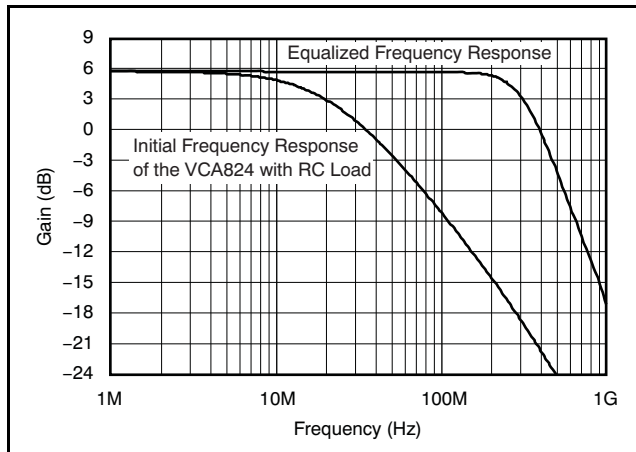

Figure 81. Differential Equalization of an RC Load

### DIFFERENTIAL CABLE EQUALIZER

A differential cable equalizer can easily be implemented using the VCA824. An example of a cable equalization for 100 feet of Belden Cable 1694F is illustrated in Figure 83, with Figure 82 showing the result for this implementation. This implementation has a maximum error of 0.2dB from dc to 70MHz.

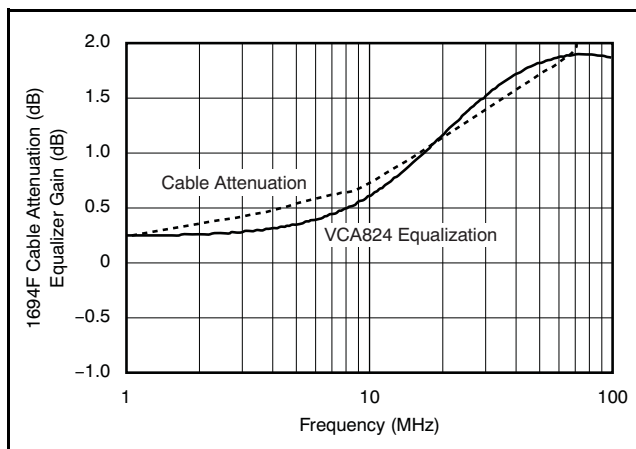
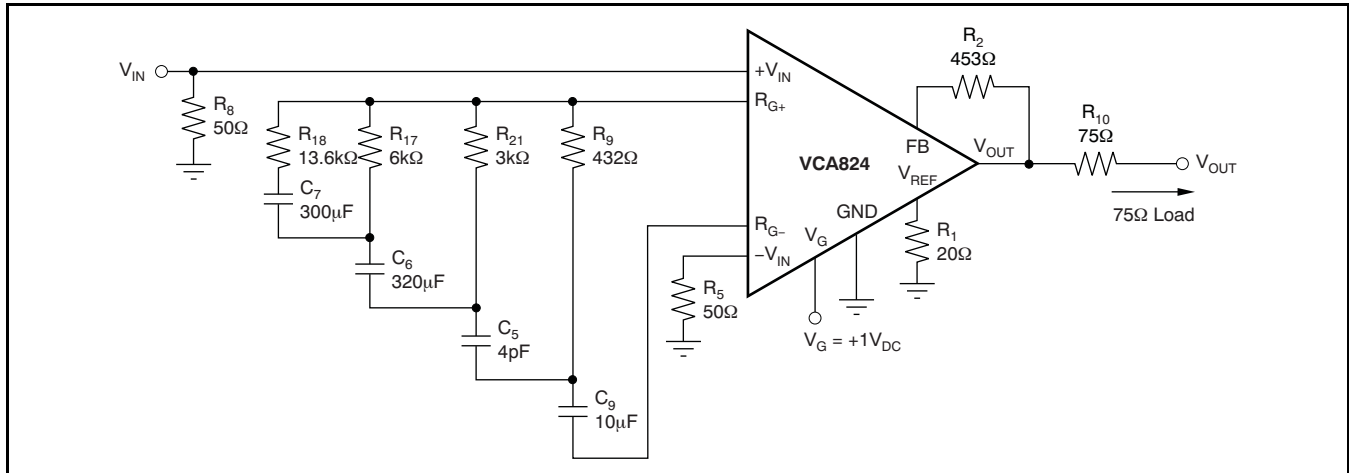

Figure 82. Cable Attenuation versus Equalizer Gain

Note that this implementation shows the cable attenuation side-by-side with the equalization in the same plot. For a given frequency, the equalization function realized with the VCA824 matches the cable attenuation. The circuit in Figure 83 is a driver circuit. To implement a receiver circuit, the signal is received differentially between the  $+V_{IN}$  and  $-V_{IN}$  inputs.

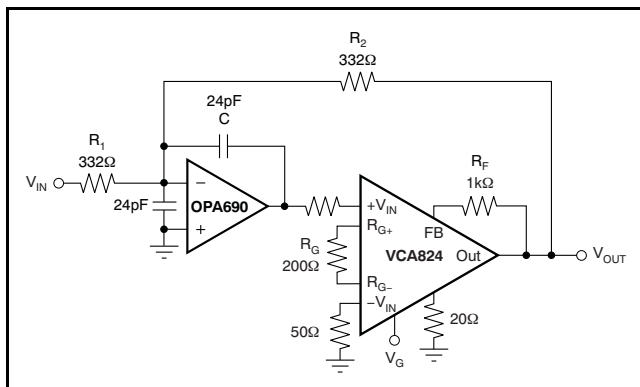

**Figure 83. Differential Cable Equalizer**

### VOLTAGE-CONTROLLED LOW-PASS FILTER

In the circuit of [Figure 84](#), the VCA824 serves as the variable-gain element of a voltage-controlled low-pass filter. This section discusses how this implementation expands the circuit voltage swing capability over that normally achieved with the equivalent multiplier implementation. The circuit control voltage,  $V_G$ , is calculated as according to the simplified relationship described in [Equation 4](#):

$$\frac{V_{OUT}}{V_{IN}} = -\frac{R_2}{R_1} \times \frac{1}{1 + s \frac{R_2 C}{G}} \quad (4)$$



**Figure 84. Voltage-Control Low-Pass Filter**

The response control results from amplification of the feedback voltage applied to  $R_2$ . First, consider the case where the VCA824 produces  $G = 1V/V$ . Then this circuit performs as if the amplifier were replaced

by a short circuit. Visually replacing the amplifier by a short leaves a simple voltage-feedback amplifier with a feedback resistor bypassed by a capacitor. Replacing this gain with a variable gain,  $G$ , the pole can be written as shown in [Equation 5](#):

$$f_8 = \frac{G}{2\pi R_2 C} \quad (5)$$

Because the VCA824 is most linear in the midrange, the median of the adjustable pole should be set at  $V_G = 0V$  (see [Figure 24](#), [Figure 44](#), [Figure 65](#), and [Equation 6](#)). Selecting  $R_1 = R_2 = 332\Omega$ , and targeting a median frequency of 10MHz, the capacitance ( $C$ ) is 24pF. Because the OPA690 was selected for the circuit of [Figure 84](#), and in order to limit peaking in the OPA690 frequency response, a capacitor equal to  $C$  was added on the inverting mode to ground. This architecture has the effect of setting the high-frequency noise gain of the OPA690 to  $+2V/V$ , ensuring stability and providing flat frequency response.

$$-0.8V \leq V_G \leq 0.8V \quad (6)$$

Once the median frequency is set, the maximum and minimum frequencies can be determined by using  $V_G = -0.8V$  and  $V_G = +0.8V$  in the gain equation of [Equation 7](#). Note that this is a first-order analysis and does not take into consideration the open-loop gain limitation of the OPA690.

$$G = 2 \times \frac{R_F}{R_G} \times \frac{V_G + 1}{2} \quad (7)$$

With the components shown, the circuit provides a linear variation of the low-pass cutoff from 2MHz to 20MHz, using  $-1V \leq V_G \leq +1V$ .

## DESIGN-IN TOOLS

### DEMONSTRATION BOARDS

Two printed circuit boards (PCBs) are available to assist in the initial evaluation of circuit performance using the VCA824 in its two package options. Both of these are offered free of charge as unpopulated PCBs, delivered with a user's guide. The summary information for these fixtures is shown in [Table 1](#).

**Table 1. EVM Ordering Information**

PRODUCT	PACKAGE	BOARD PART NUMBER	LITERATURE REQUEST NUMBER
VCA824ID	SO-14	DEM-VCA-SO-1B	<a href="#">SBOU050</a>
VCA824IDGS	MSOP-10	DEM-VCA-MSOP-1A	<a href="#">SBOU051</a>

The demonstration fixtures can be requested at the Texas Instruments web site ([www.ti.com](http://www.ti.com)) through the VCA824 product folder.

### MACROMODELS AND APPLICATIONS SUPPORT

Computer simulation of circuit performance using SPICE is often useful when analyzing the performance of analog circuits and systems. This principle is particularly true for video and RF amplifier circuits where parasitic capacitance and inductance can play a major role in circuit performance. A [SPICE model](#) for the VCA824 is available through the TI web page. The applications group is also available for design assistance. The models available from TI

predict typical small-signal ac performance, transient steps, dc performance, and noise under a wide variety of operating conditions. The models include the noise terms found in the electrical specifications of the relevant product data sheet.

### OPERATING SUGGESTIONS

Operating the VCA824 optimally for a specific application requires trade-offs between bandwidth, input dynamic range and the maximum input voltage, the maximum gain of operation and gain, output dynamic range and the maximum input voltage, the package used, loading, and layout and bypass recommendations. The [Typical Characteristics](#) have been defined to cover as much ground as possible to describe the VCA824 operation. There are four sections in the Typical Characteristics:

- $V_S = \pm 5V$  [DC Parameters](#) and  $V_S = \pm 5V$  [DC and Power-Supply Parameters](#), which include dc operation and the intrinsic limitation of a VCA824 design
- $V_S = \pm 5V$ ,  $A_{VMAX} = +2V/V$  [Gain of +2V/V Operation](#)
- $V_S = \pm 5V$ ,  $A_{VMAX} = +10V/V$  [Gain of +10V/V Operation](#)
- $V_S = \pm 5V$ ,  $A_{VMAX} = +40V/V$  [Gain of +40V/V Operation](#)

Where the Typical Characteristics describe the actual performance that can be achieved by using the amplifier properly, the following sections describe in detail the trade-offs needed to achieve this level of performance.

## PACKAGE CONSIDERATIONS

The VCA824 is available in both SO-14 and MSOP-10 packages. Each package has, for the different gains used in the typical characteristics, different values of  $R_F$  and  $R_G$  in order to achieve the same performance detailed in the [Electrical Characteristics](#) table.

Figure 85 shows a test gain circuit for the VCA824. Table 2 lists the recommended configuration for the SO-14 and MSOP-10 packages.

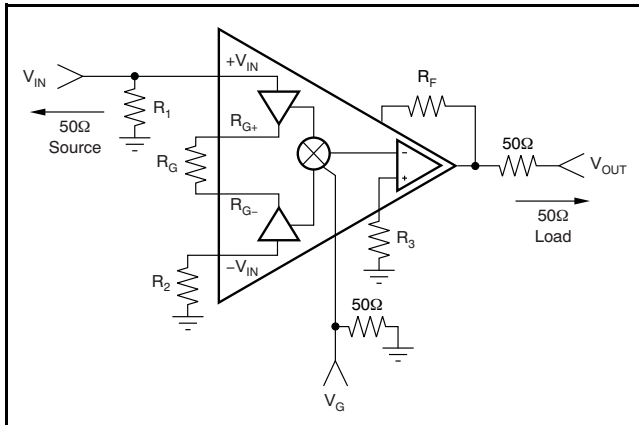

Figure 85. Test Circuit

Table 2. SO-14 and MSOP-10  $R_F$  and  $R_G$  Configurations

	G = 2	G = 10	G = 100
$R_F$	453Ω	402Ω	402Ω
$R_G$	453Ω	80Ω	18Ω

There are no differences between the packages in the recommended values for the gain and feedback resistors. However, the bandwidth for the VCA824IDGS (MSOP-10 package) is lower than the bandwidth for the VCA824ID (SO-14 package). This difference is true for all gains, but especially true for gains greater than 5V/V, as can be seen in [Figure 86](#) and [Figure 87](#). Note that the scale must be changed to a linear scale to view the details.

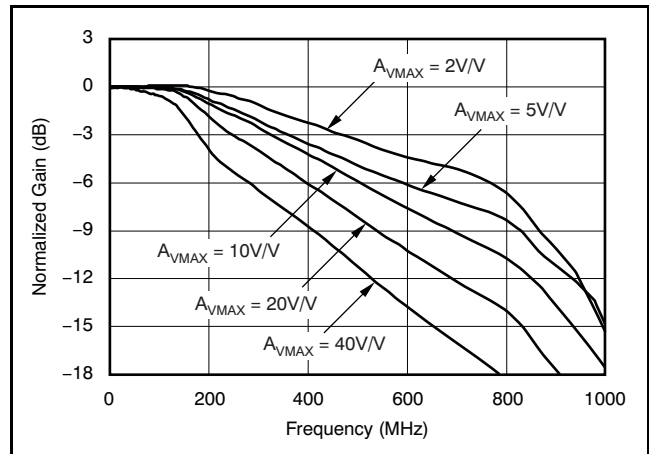

Figure 86. SO-14 Recommended  $R_F$  and  $R_G$  versus  $A_{VMAX}$

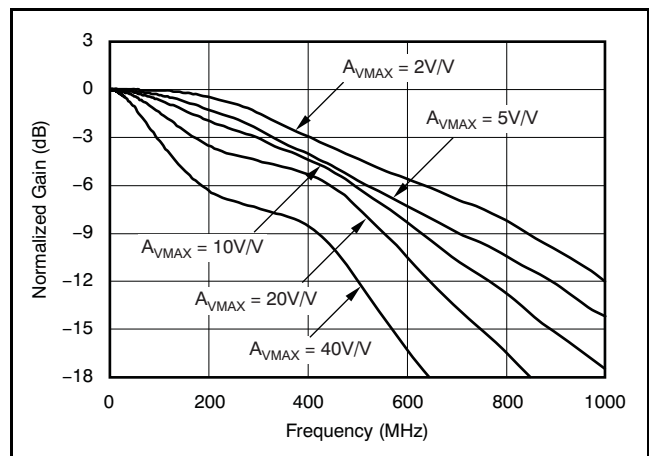

Figure 87. MSOP-10 Recommended  $R_F$  and  $R_G$  versus  $A_{VMAX}$



## MAXIMUM GAIN OF OPERATION

This section describes the use of the VCA824 in a fixed-gain application in which the  $V_G$  control pin is set at  $V_G = +1V$ . The tradeoffs described here are with bandwidth, gain, and output voltage range.

In the case of an application that does not make use of the  $V_{GAIN}$ , but requires some other characteristic of the VCA824, the  $R_G$  resistor must be set such that the maximum current flowing through the resistance  $I_{RG}$  is less than  $\pm 2.6mA$  typical, or  $5.2mA_{PP}$  as defined in the [Electrical Characteristics](#) table, and must follow [Equation 8](#).

$$I_{RG} = \frac{V_{OUT}}{A_{VMAX} \times R_G} \quad (8)$$

As [Equation 8](#) illustrates, once the output dynamic range and maximum gain are defined, the gain resistor is set. This gain setting in turn affects the bandwidth, because in order to achieve the gain (and with a set gain element), the feedback element of the output stage amplifier is set as well. Keeping in mind that the output amplifier of the VCA824 is a current-feedback amplifier, the larger the feedback element, the lower the bandwidth because the feedback resistor is the compensation element.

Limiting the discussion to the input voltage only and ignoring the output voltage and gain, [Figure 1](#) illustrates the tradeoff between the input voltage and the current flowing through the gain resistor.

## OUTPUT CURRENT AND VOLTAGE

The VCA824 provides output voltage and current capabilities that are unsurpassed in a low-cost monolithic VCA. Under no-load conditions at  $+25^\circ C$ , the output voltage typically swings closer than 1V to either supply rails; the  $+25^\circ C$  swing limit is within 1.2V of either rails. Into a  $15\Omega$  load (the minimum tested load), it is tested to deliver more than  $\pm 160mA$ .

The specifications described above, though familiar in the industry, consider voltage and current limits separately. In many applications, it is the voltage  $\times$  current, or *V-I product*, that is more relevant to circuit operation. Refer to the *Output Voltage and Current Limitations* plot ([Figure 49](#)) in the *Typical Characteristics*. The X- and Y-axes of this graph show the zero-voltage output current limit and the zero-current output voltage limit, respectively. The four quadrants give a more detailed view of the VCA824 output drive capabilities, noting that the graph is bounded by a *Safe Operating Area* of 1W maximum internal power dissipation. Superimposing resistor load lines onto the plot shows that the

VCA824 can drive  $\pm 2.5V$  into  $25\Omega$  or  $\pm 3.5V$  into  $50\Omega$  without exceeding the output capabilities or the 1W dissipation limit. A  $100\Omega$  load line (the standard test circuit load) shows the full  $\pm 3.9V$  output swing capability, as shown in the [Typical Characteristics](#).

The minimum specified output voltage and current over-temperature are set by worst-case simulations at the cold temperature extreme. Only at cold startup do the output current and voltage decrease to the numbers shown in the [Electrical Characteristic](#) tables. As the output transistors deliver power, the respective junction temperatures increase, thereby increasing the available output voltage swing and output current.

In steady-state operation, the available output voltage and current are always greater than the temperature shown in the over-temperature specifications because the output stage junction temperatures are higher than the specified operating ambient.

## INPUT VOLTAGE DYNAMIC RANGE

The VCA824 has a input dynamic range limited to  $+1.6V$  and  $-2.1V$ . Increasing the input voltage dynamic range can be done by using an attenuator network on the input. If the VCA824 is trying to regulate the amplitude at the output, such as in an AGC application, the input voltage dynamic range is directly proportional to [Equation 9](#).

$$V_{IN(PP)} = R_G \times I_{RG(PP)} \quad (9)$$

As such, for unity-gain or under-attenuated conditions, the input voltage must be limited to the CMIR of  $\pm 1.6V$  ( $3.2V_{PP}$ ) and the current ( $I_{RQ}$ ) must flow through the gain resistor,  $\pm 2.6mA$  ( $5.2mA_{PP}$ ). This configuration sets a minimum value for  $R_E$  such that the gain resistor must be greater than [Equation 10](#).

$$R_{GMIN} = \frac{3.2V_{PP}}{5.2mA_{PP}} = 615.4\Omega \quad (10)$$

Values lower than  $615.4\Omega$  are gain elements that result in reduced input range, as the dynamic input range is limited by the current flowing through the gain resistor  $R_G$  ( $I_{RG}$ ). If the  $I_{RG}$  current limits the performance of the circuit, the input stage of the VCA824 goes into overdrive, resulting in limited output voltage range. Such  $I_{RG}$ -limited overdrive conditions are shown in [Figure 51](#) for the gain of  $+10V/V$  and [Figure 71](#) for the  $+40V/V$  gain.

## OUTPUT VOLTAGE DYNAMIC RANGE

With its large output current capability and its wide output voltage swing of  $\pm 3.9\text{V}$  typical on  $100\Omega$  load, it is easy to forget other types of limitations that the VCA824 can encounter. For these limitations, careful analysis must be done to avoid input stage limitation: either voltage or  $I_{RG}$  current. Note that if control pin  $V_G$  varies, the gain limitation may affect other aspects of the circuit.

## BANDWIDTH

The output stage of the VCA824 is a wideband current-feedback amplifier. As such, the feedback resistance is the compensation of the last stage. Reducing the feedback element and maintaining the gain constant limits the useful range of  $I_{RG}$ , and therefore, reduces the gain adjust range. For a given gain, reducing the gain element limits the maximum achievable output voltage swing.

## OFFSET ADJUSTMENT

As a result of the internal architecture used on the VCA824, the output offset voltage originates from the output stage and from the input stage and multiplier core. [Figure 88](#) shows how to compensate both sources of the output offset voltage. Use this procedure to compensate the output offset voltage: starting with the output stage compensation, set  $V_G = -1\text{V}$  to eliminate all offset contribution of the input stage and multiplier core. Adjust the output stage offset compensation potentiometer. Finally, set  $V_G = +1\text{V}$  to the maximum gain and adjust the input stage and multiplier core potentiometer. This procedure effectively eliminates all offset contribution at the maximum gain. Because adjusting the gain modifies the contribution of the input stage and the multiplier core, some residual output offset voltage remains.

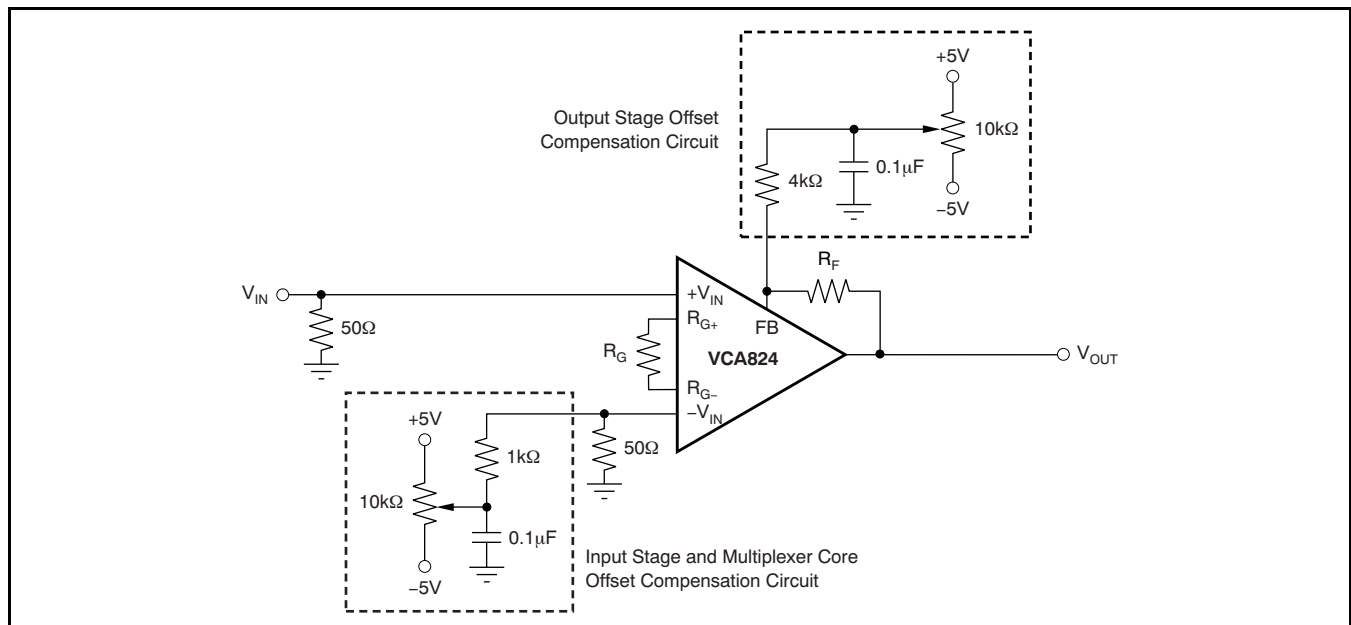

**Figure 88. Adjusting the Input and Output Voltage Sources**

**NOISE**

The VCA824 offers  $6\text{nV}/\sqrt{\text{Hz}}$  input-referred voltage noise density at a gain of  $+10\text{V}/\text{V}$  and  $2.6\text{pA}/\sqrt{\text{Hz}}$  input-referred current noise density. The input-referred voltage noise density considers that all noise terms (except the input current noise but including the thermal noise of both the feedback resistor and the gain resistor) are expressed as one term.

This model is formulated in Equation 11 and Figure 89.

$$e_o = A_{\text{VMAX}} \times \sqrt{2 \times (R_s \times i_n)^2 + e_n^2 + 2 \times 4\text{kTR}_s} \quad (11)$$

A more complete model is shown in Figure 90. For additional information on this model and the actual modeled noise terms, please contact the High-Speed Product Application Support team at [www.ti.com](http://www.ti.com).

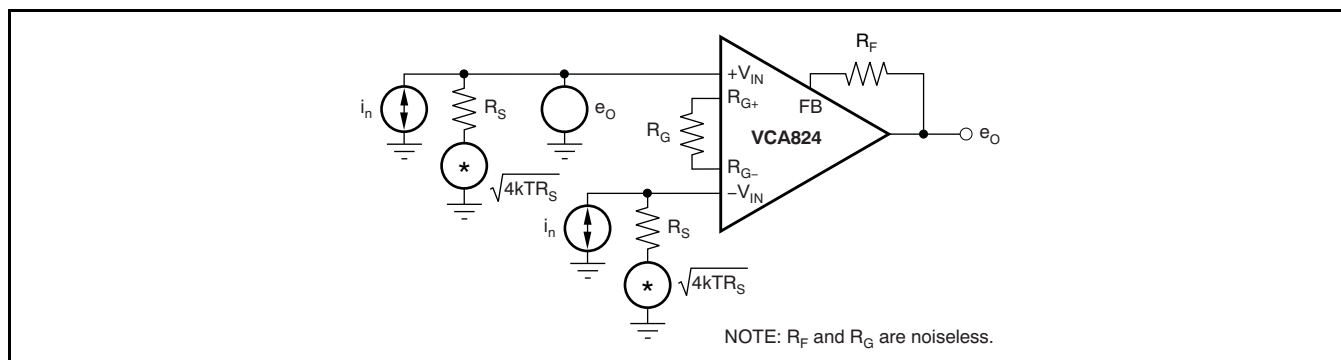

**Figure 89. Simple Noise Model**

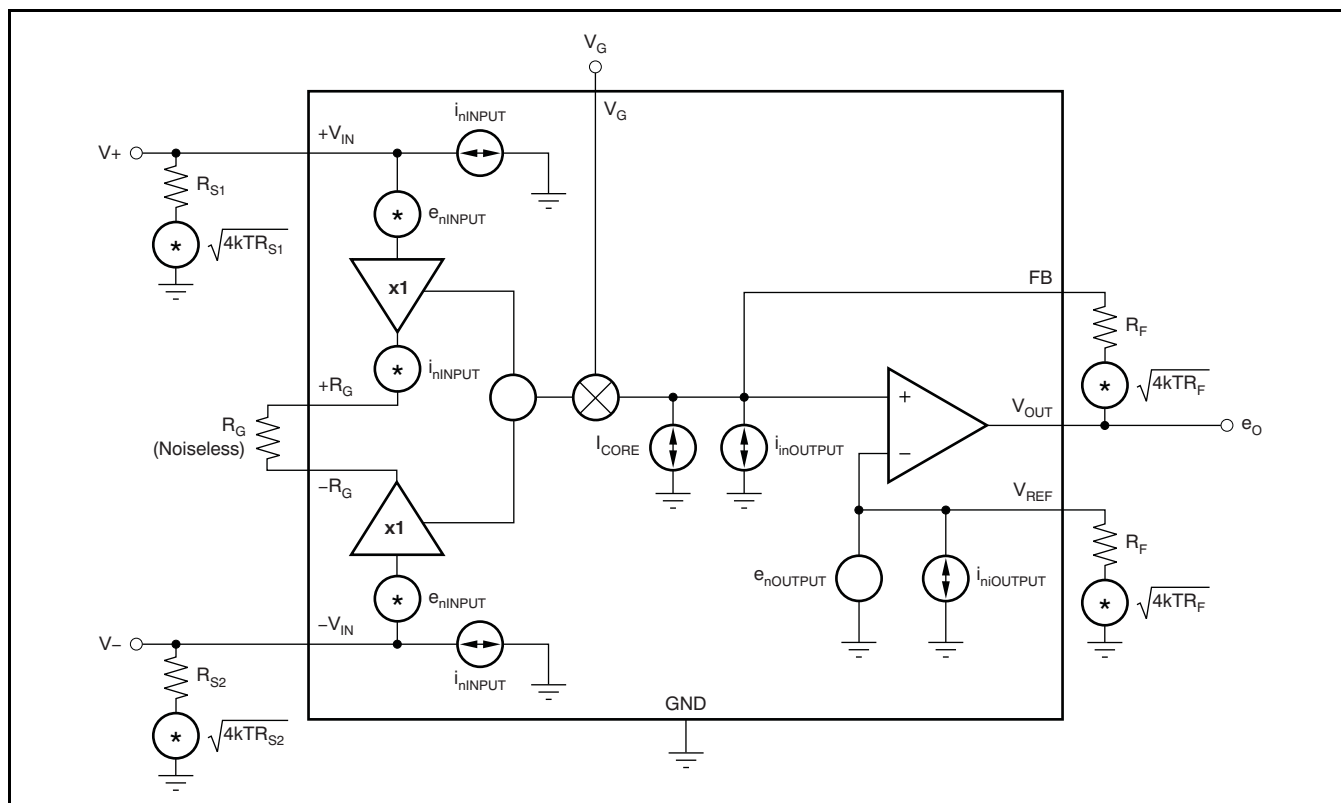

**Figure 90. Full Noise Model**

## THERMAL ANALYSIS

The VCA824 does not require heatsinking or airflow in most applications. The maximum desired junction temperature sets the maximum allowed internal power dissipation as described in this section. In no case should the maximum junction temperature be allowed to exceed +150°C.

Operating junction temperature ( $T_J$ ) is given by [Equation 12](#):

$$T_J = T_A + P_D \times \theta_{JA} \quad (12)$$

The total internal power dissipation ( $P_D$ ) is the sum of quiescent power ( $P_{DQ}$ ) and additional power dissipated in the output stage ( $P_{DL}$ ) to deliver load power. Quiescent power is simply the specified no-load supply current times the total supply voltage across the part.  $P_{DL}$  depends on the required output signal and load; for a grounded resistive load, however, it is at a maximum when the output is fixed at a voltage equal to one-half of either supply voltage (for equal bipolar supplies). Under this worst-case condition,  $P_{DL} = V_S^2 / (4 \times R_L)$ , where  $R_L$  is the resistive load.

Note that it is the power in the output stage and not in the load that determines internal power dissipation. As a worst-case example, compute the maximum  $T_J$  using a VCA824ID (SO-14 package) in the circuit of [Figure 75](#) operating at maximum gain and at the maximum specified ambient temperature of +85°C.

$$P_D = 10V(38.5mA) + 5^2 / (4 \times 100\Omega) = 447.5mW \quad (13)$$

$$\text{Maximum } T_J = +85^\circ\text{C} + (0.449W \times 80^\circ\text{C/W}) = 120.8^\circ\text{C} \quad (14)$$

This maximum operating junction temperature is well below most system level targets. Most applications should be lower because an absolute worst-case output stage power was assumed in this calculation of  $V_{CC}/2$ , which is beyond the output voltage range for the VCA824.

## BOARD LAYOUT

Achieving optimum performance with a high-frequency amplifier such as the VCA824 requires careful attention to printed circuit board (PCB) layout parasitics and external component types. Recommendations to optimize performance include:

**a) Minimize parasitic capacitance** to any ac ground for all of the signal I/O pins. This recommendation includes the ground pin (pin 2). Parasitic capacitance on the output can cause instability: on both the inverting input and the noninverting input, it can react with the source impedance to cause unintentional

band limiting. To reduce unwanted capacitance, a window around the signal I/O pins should be opened in all of the ground and power planes around those pins. Otherwise, ground and power planes should be unbroken elsewhere on the board. Place a small series resistance (greater than 25Ω) with the input pin connected to ground to help decouple package parasitics.

**b) Minimize the distance** (less than 0.25 inches) from the power-supply pins to high-frequency 0.1μF decoupling capacitors. At the device pins, the ground and power plane layout should not be in close proximity to the signal I/O pins. Avoid narrow power and ground traces to minimize inductance between the pins and the decoupling capacitors. The power-supply connections should always be decoupled with these capacitors. Larger (2.2μF to 6.8μF) decoupling capacitors, effective at lower frequencies, should also be used on the main supply pins. These capacitors may be placed somewhat farther from the device and may be shared among several devices in the same area of the PCB.

**c) Careful selection and placement** of external components preserve the high-frequency performance of the VCA824. Resistors should be a very low reactance type. Surface-mount resistors work best and allow a tighter overall layout. Metal-film and carbon composition, axially-leaded resistors can also provide good high-frequency performance. Again, keep the leads and PCB trace length as short as possible. Never use wire-wound type resistors in a high-frequency application. Because the output pin is the most sensitive to parasitic capacitance, always position the series output resistor, if any, as close as possible to the output pin. Other network components, such as inverting or non-inverting input termination resistors, should also be placed close to the package.

**d) Connections to other wideband devices** on the board may be made with short direct traces or through onboard transmission lines. For short connections, consider the trace and the input to the next device as a lumped capacitive load. Relatively wide traces (50mils to 100mils, or 1.27mm to 2.54mm) should be used, preferably with ground and power planes opened up around them.

**e) Socketing a high-speed part like the VCA824 is not recommended.** The additional lead length and pin-to-pin capacitance introduced by the socket can create an extremely troublesome parasitic network, which can make it almost impossible to achieve a smooth, stable frequency response. Best results are obtained by soldering the VCA824 onto the board.

## INPUT AND ESD PROTECTION

The VCA824 is built using a very high-speed complementary bipolar process. The internal junction breakdown voltages are relatively low for these very small geometry devices. These breakdowns are reflected in the [Absolute Maximum Ratings](#) table.

All pins on the VCA824 are internally protected from ESD by means of a pair of back-to-back reverse-biased diodes to either power supply, as shown in [Figure 91](#). These diodes begin to conduct when the pin voltage exceeds either power supply by about 0.7V. This situation can occur with loss of the amplifier power supplies while a signal source is still present. The diodes can typically withstand a continuous current of 30mA without destruction. To ensure long-term reliability, however, diode current should be externally limited to 10mA whenever possible.

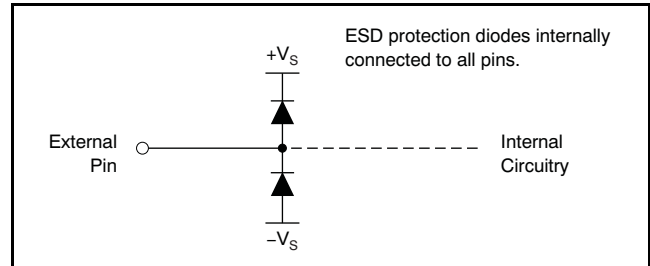

**Figure 91. Internal ESD Protection**

## Revision History

NOTE: Page numbers for previous revisions may differ from page numbers in the current version.

<b>Changes from Revision A (December 2007) to Revision B</b>	<b>Page</b>
<ul style="list-style-type: none"> <li>• Changed storage temperature range rating in <i>Absolute Maximum Ratings</i> table from <math>-40^{\circ}\text{C}</math> to <math>+125^{\circ}\text{C}</math> to <math>-65^{\circ}\text{C}</math> to <math>+125^{\circ}\text{C}</math>..... 2</li> </ul>	2
<b>Changes from Original (November 2007) to Revision A</b>	<b>Page</b>
<ul style="list-style-type: none"> <li>• Added typical value for output impedance..... 4</li> <li>• Corrected y-axis units; changed from (V/V) to (dB)..... 5</li> <li>• Corrected y-axis units; changed from (V/V) to (dB)..... 5</li> <li>• Changed wording of explanation for X2Y capacitor usage at end of paragraph..... 19</li> <li>• Corrected section title description..... 23</li> </ul>	4 5 5 19 23

**PACKAGING INFORMATION**

Orderable Device	Status <sup>(1)</sup>	Package Type	Package Drawing	Pins	Package Qty	Eco Plan <sup>(2)</sup>	Lead/Ball Finish	MSL Peak Temp <sup>(3)</sup>
VCA824ID	ACTIVE	SOIC	D	14	50	Green (RoHS & no Sb/Br)	CU NIPDAU	Level-2-260C-1 YEAR
VCA824IDG4	ACTIVE	SOIC	D	14	50	Green (RoHS & no Sb/Br)	CU NIPDAU	Level-2-260C-1 YEAR
VCA824IDGSR	ACTIVE	MSOP	DGS	10	2500	Green (RoHS & no Sb/Br)	CU NIPDAU	Level-2-260C-1 YEAR
VCA824IDGSRG4	ACTIVE	MSOP	DGS	10	2500	Green (RoHS & no Sb/Br)	CU NIPDAU	Level-2-260C-1 YEAR
VCA824IDGST	ACTIVE	MSOP	DGS	10	250	Green (RoHS & no Sb/Br)	CU NIPDAU	Level-2-260C-1 YEAR
VCA824IDGSTG4	ACTIVE	MSOP	DGS	10	250	Green (RoHS & no Sb/Br)	CU NIPDAU	Level-2-260C-1 YEAR
VCA824IDR	ACTIVE	SOIC	D	14	2500	Green (RoHS & no Sb/Br)	CU NIPDAU	Level-2-260C-1 YEAR
VCA824IDRG4	ACTIVE	SOIC	D	14	2500	Green (RoHS & no Sb/Br)	CU NIPDAU	Level-2-260C-1 YEAR

<sup>(1)</sup> The marketing status values are defined as follows:

**ACTIVE:** Product device recommended for new designs.

**LIFEBUY:** TI has announced that the device will be discontinued, and a lifetime-buy period is in effect.

**NRND:** Not recommended for new designs. Device is in production to support existing customers, but TI does not recommend using this part in a new design.

**PREVIEW:** Device has been announced but is not in production. Samples may or may not be available.

**OBSOLETE:** TI has discontinued the production of the device.

<sup>(2)</sup> Eco Plan - The planned eco-friendly classification: Pb-Free (RoHS), Pb-Free (RoHS Exempt), or Green (RoHS & no Sb/Br) - please check <http://www.ti.com/productcontent> for the latest availability information and additional product content details.

**TBD:** The Pb-Free/Green conversion plan has not been defined.

**Pb-Free (RoHS):** TI's terms "Lead-Free" or "Pb-Free" mean semiconductor products that are compatible with the current RoHS requirements for all 6 substances, including the requirement that lead not exceed 0.1% by weight in homogeneous materials. Where designed to be soldered at high temperatures, TI Pb-Free products are suitable for use in specified lead-free processes.

**Pb-Free (RoHS Exempt):** This component has a RoHS exemption for either 1) lead-based flip-chip solder bumps used between the die and package, or 2) lead-based die adhesive used between the die and leadframe. The component is otherwise considered Pb-Free (RoHS compatible) as defined above.

**Green (RoHS & no Sb/Br):** TI defines "Green" to mean Pb-Free (RoHS compatible), and free of Bromine (Br) and Antimony (Sb) based flame retardants (Br or Sb do not exceed 0.1% by weight in homogeneous material)

<sup>(3)</sup> MSL, Peak Temp. -- The Moisture Sensitivity Level rating according to the JEDEC industry standard classifications, and peak solder temperature.

**Important Information and Disclaimer:**The information provided on this page represents TI's knowledge and belief as of the date that it is provided. TI bases its knowledge and belief on information provided by third parties, and makes no representation or warranty as to the accuracy of such information. Efforts are underway to better integrate information from third parties. TI has taken and continues to take reasonable steps to provide representative and accurate information but may not have conducted destructive testing or chemical analysis on incoming materials and chemicals. TI and TI suppliers consider certain information to be proprietary, and thus CAS numbers and other limited information may not be available for release.

In no event shall TI's liability arising out of such information exceed the total purchase price of the TI part(s) at issue in this document sold by TI to Customer on an annual basis.

**TAPE AND REEL INFORMATION**



A0	Dimension designed to accommodate the component width
B0	Dimension designed to accommodate the component length
K0	Dimension designed to accommodate the component thickness
W	Overall width of the carrier tape
P1	Pitch between successive cavity centers

**QUADRANT ASSIGNMENTS FOR PIN 1 ORIENTATION IN TAPE**

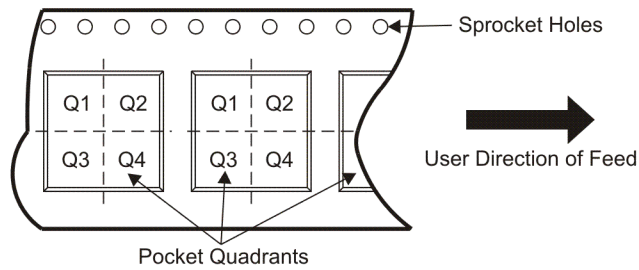

\*All dimensions are nominal

Device	Package Type	Package Drawing	Pins	SPQ	Reel Diameter (mm)	Reel Width W1 (mm)	A0 (mm)	B0 (mm)	K0 (mm)	P1 (mm)	W (mm)	Pin1 Quadrant
VCA824IDGSR	MSOP	DGS	10	2500	330.0	12.4	5.3	3.4	1.4	8.0	12.0	Q1
VCA824IDGST	MSOP	DGS	10	250	180.0	12.4	5.3	3.4	1.4	8.0	12.0	Q1
VCA824IDR	SOIC	D	14	2500	330.0	16.4	6.5	9.0	2.1	8.0	16.0	Q1



**TAPE AND REEL BOX DIMENSIONS**



\*All dimensions are nominal

Device	Package Type	Package Drawing	Pins	SPQ	Length (mm)	Width (mm)	Height (mm)
VCA824IDGSR	MSOP	DGS	10	2500	346.0	346.0	29.0
VCA824IDGST	MSOP	DGS	10	250	190.5	212.7	31.8
VCA824IDR	SOIC	D	14	2500	346.0	346.0	33.0

DGS (S-PDSO-G10)

PLASTIC SMALL-OUTLINE PACKAGE

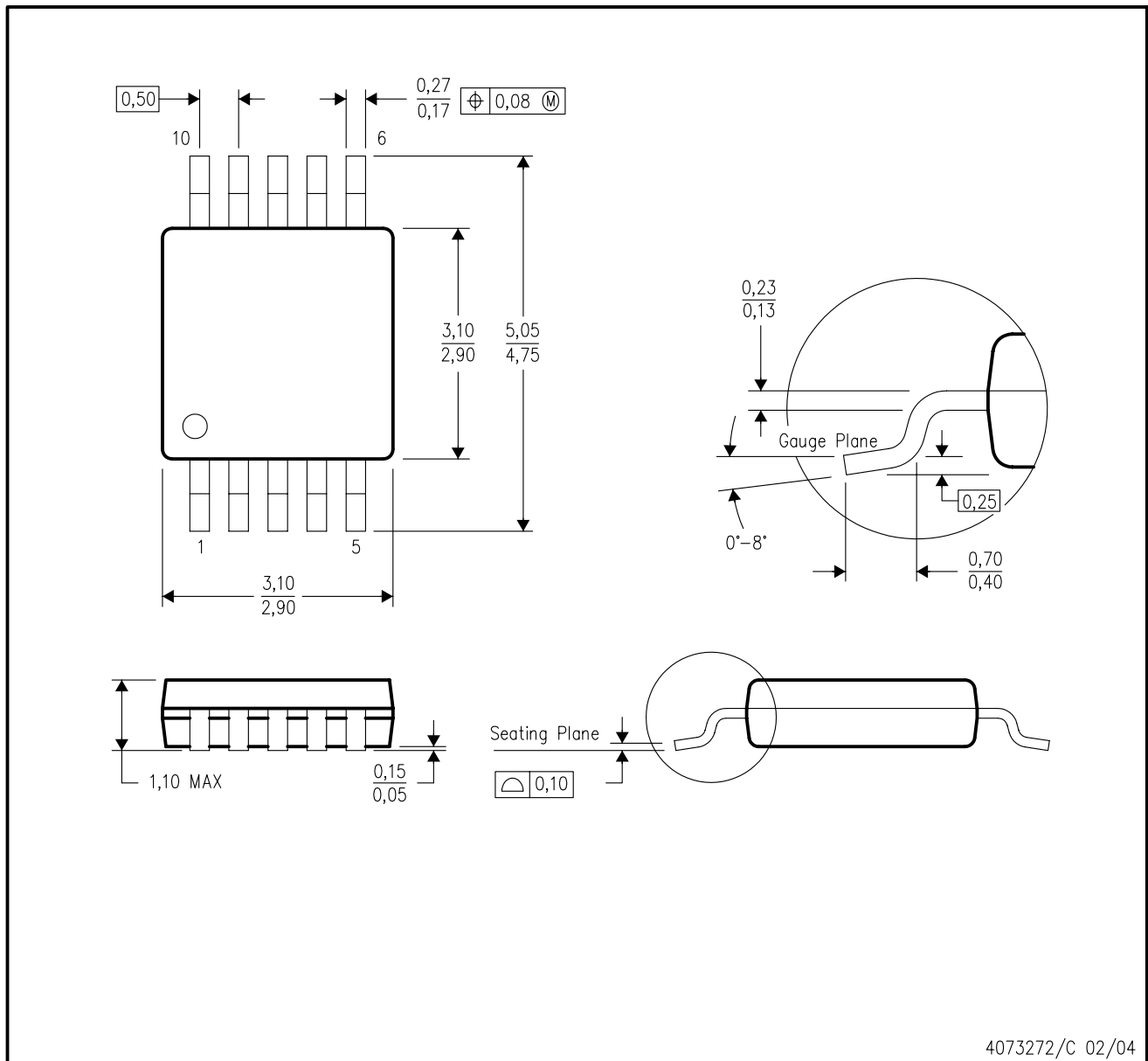

- NOTES:
- A. All linear dimensions are in millimeters.
  - B. This drawing is subject to change without notice.
  - C. Body dimensions do not include mold flash or protrusion.
  - D. Falls within JEDEC MO-187 variation BA.

D (R-PDSO-G14)

PLASTIC SMALL-OUTLINE PACKAGE

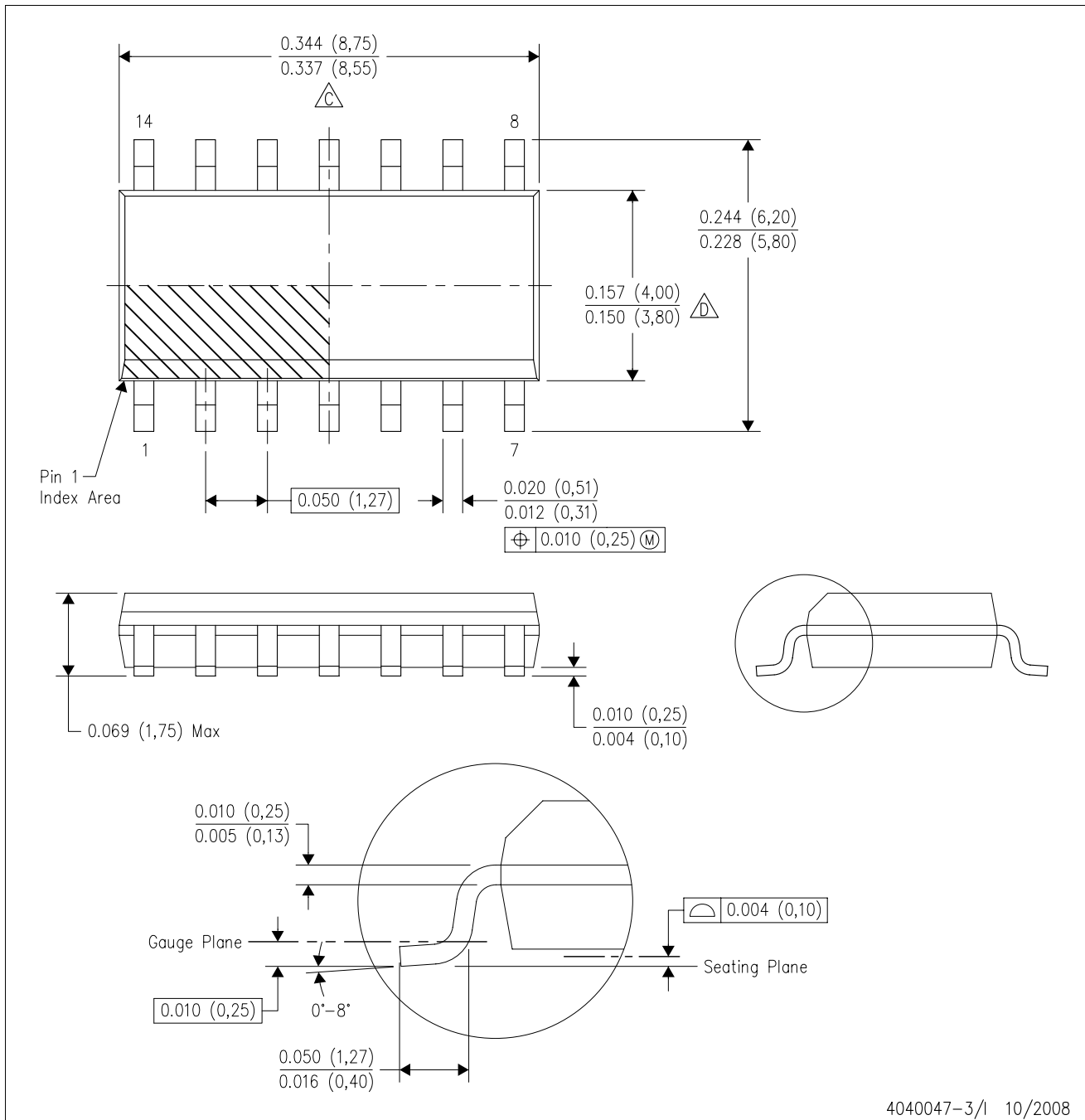

- NOTES:
- A. All linear dimensions are in inches (millimeters).
  - B. This drawing is subject to change without notice.
  - C. Body length does not include mold flash, protrusions, or gate burrs. Mold flash, protrusions, or gate burrs shall not exceed .006 (0,15) per end.
  - D. Body width does not include interlead flash. Interlead flash shall not exceed .017 (0,43) per side.
  - E. Reference JEDEC MS-012 variation AB.

## IMPORTANT NOTICE

Texas Instruments Incorporated and its subsidiaries (TI) reserve the right to make corrections, modifications, enhancements, improvements, and other changes to its products and services at any time and to discontinue any product or service without notice. Customers should obtain the latest relevant information before placing orders and should verify that such information is current and complete. All products are sold subject to TI's terms and conditions of sale supplied at the time of order acknowledgment.

TI warrants performance of its hardware products to the specifications applicable at the time of sale in accordance with TI's standard warranty. Testing and other quality control techniques are used to the extent TI deems necessary to support this warranty. Except where mandated by government requirements, testing of all parameters of each product is not necessarily performed.

TI assumes no liability for applications assistance or customer product design. Customers are responsible for their products and applications using TI components. To minimize the risks associated with customer products and applications, customers should provide adequate design and operating safeguards.

TI does not warrant or represent that any license, either express or implied, is granted under any TI patent right, copyright, mask work right, or other TI intellectual property right relating to any combination, machine, or process in which TI products or services are used. Information published by TI regarding third-party products or services does not constitute a license from TI to use such products or services or a warranty or endorsement thereof. Use of such information may require a license from a third party under the patents or other intellectual property of the third party, or a license from TI under the patents or other intellectual property of TI.

Reproduction of TI information in TI data books or data sheets is permissible only if reproduction is without alteration and is accompanied by all associated warranties, conditions, limitations, and notices. Reproduction of this information with alteration is an unfair and deceptive business practice. TI is not responsible or liable for such altered documentation. Information of third parties may be subject to additional restrictions.

Resale of TI products or services with statements different from or beyond the parameters stated by TI for that product or service voids all express and any implied warranties for the associated TI product or service and is an unfair and deceptive business practice. TI is not responsible or liable for any such statements.

TI products are not authorized for use in safety-critical applications (such as life support) where a failure of the TI product would reasonably be expected to cause severe personal injury or death, unless officers of the parties have executed an agreement specifically governing such use. Buyers represent that they have all necessary expertise in the safety and regulatory ramifications of their applications, and acknowledge and agree that they are solely responsible for all legal, regulatory and safety-related requirements concerning their products and any use of TI products in such safety-critical applications, notwithstanding any applications-related information or support that may be provided by TI. Further, Buyers must fully indemnify TI and its representatives against any damages arising out of the use of TI products in such safety-critical applications.

TI products are neither designed nor intended for use in military/aerospace applications or environments unless the TI products are specifically designated by TI as military-grade or "enhanced plastic." Only products designated by TI as military-grade meet military specifications. Buyers acknowledge and agree that any such use of TI products which TI has not designated as military-grade is solely at the Buyer's risk, and that they are solely responsible for compliance with all legal and regulatory requirements in connection with such use.

TI products are neither designed nor intended for use in automotive applications or environments unless the specific TI products are designated by TI as compliant with ISO/TS 16949 requirements. Buyers acknowledge and agree that, if they use any non-designated products in automotive applications, TI will not be responsible for any failure to meet such requirements.

Following are URLs where you can obtain information on other Texas Instruments products and application solutions:

### Products

Amplifiers	<a href="http://amplifier.ti.com">amplifier.ti.com</a>
Data Converters	<a href="http://dataconverter.ti.com">dataconverter.ti.com</a>
DSP	<a href="http://dsp.ti.com">dsp.ti.com</a>
Clocks and Timers	<a href="http://www.ti.com/clocks">www.ti.com/clocks</a>
Interface	<a href="http://interface.ti.com">interface.ti.com</a>
Logic	<a href="http://logic.ti.com">logic.ti.com</a>
Power Mgmt	<a href="http://power.ti.com">power.ti.com</a>
Microcontrollers	<a href="http://microcontroller.ti.com">microcontroller.ti.com</a>
RFID	<a href="http://www.ti-rfid.com">www.ti-rfid.com</a>
RF/IF and ZigBee® Solutions	<a href="http://www.ti.com/lprf">www.ti.com/lprf</a>

### Applications

Audio	<a href="http://www.ti.com/audio">www.ti.com/audio</a>
Automotive	<a href="http://www.ti.com/automotive">www.ti.com/automotive</a>
Broadband	<a href="http://www.ti.com/broadband">www.ti.com/broadband</a>
Digital Control	<a href="http://www.ti.com/digitalcontrol">www.ti.com/digitalcontrol</a>
Medical	<a href="http://www.ti.com/medical">www.ti.com/medical</a>
Military	<a href="http://www.ti.com/military">www.ti.com/military</a>
Optical Networking	<a href="http://www.ti.com/opticalnetwork">www.ti.com/opticalnetwork</a>
Security	<a href="http://www.ti.com/security">www.ti.com/security</a>
Telephony	<a href="http://www.ti.com/telephony">www.ti.com/telephony</a>
Video & Imaging	<a href="http://www.ti.com/video">www.ti.com/video</a>
Wireless	<a href="http://www.ti.com/wireless">www.ti.com/wireless</a>

Mailing Address: Texas Instruments, Post Office Box 655303, Dallas, Texas 75265  
Copyright © 2008, Texas Instruments Incorporated